

LIST

线性灯具产品手册

INTERIOR LINEAR LIGHTING
HANDBOOK

上海开狄照明科技有限公司
www.kdlighting.cn

2022.03

<p>ALP143 P01</p>	<p>ALP144 P01</p>	<p>ALP145 P02</p>	<p>ALP146 P02</p>	<p>ALP001-R P03</p>
<p>ALP002-R P04</p>	<p>ALP002-RL P05</p>	<p>ALP004-RL P06</p>	<p>ALP003-R P07</p>	<p>ALP004-R P08</p>
<p>ALP005 P09</p>	<p>ALP006 P10</p>	<p>ALP007-R P11</p>	<p>ALP008 P12</p>	<p>ALP010 P13</p>
<p>ALP011 P14</p>	<p>ALP012 P14</p>	<p>ALP027 P15</p>	<p>ALP029 P15</p>	<p>ALP028 P16</p>
<p>ALP013-R P17</p>	<p>ALP014-R P18</p>	<p>ALP013 P19</p>	<p>ALP014 P19</p>	<p>ALP031 P20</p>
<p>ALP032 P20</p>	<p>ALP015-R P21</p>	<p>ALP016-R P22</p>	<p>ALP021 P23</p>	<p>ALP077 P24</p>
<p>ALP043 P25</p>	<p>ALP044 P25</p>	<p>ALP044-PC-R P26</p>	<p>ALP025 P27</p>	<p>ALP026 P27</p>

ALP073 P29 	ALP096 P30 	ALP097 P30 	ALP116 P31 	ALP117 P31
ALP035-R P33 	ALP035-RL P34 	ALP119 P35 	ALP140 P36 	ALP100 P37
ALP099 P38 	ALP039 P39 	ALP039-30 P39 	ALP039-60 P39 	ALP039-90 P39
ALP040 P40 	ALP040-30 P40 	ALP040-60 P40 	ALP040-90 P40 	ALP134 P41
ALP135 P41 	ALP136 P42 	ALP137 P42 	ALP138 P43 	ALP139 P43
ALP180 P44 	ALP181 P44 	ALP109 P45 	ALP106 P45 	ALP104 P46
ALP105 P46 	ALP107 P47 	ALP108 P47 	ALP017-R P48 	ALP018 P48

ALP045 P49 	ALP046 P49 	ALP047 P50 	ALP048 P50 	ALP017-R5 P51
ALP018-R3 P52 	ALP045-R P53 	ALP046-R P54 	ALP047-R1 P55 	ALP048-R1 P56
ALP6535 P57 	ALP5035 P57 	ALP9035 P58 	ALP7535 P58 	ALP12335 P59
ALP059-R P60 	ALP114 P61 	ALP050 P63 	ALP062 P63 	ALP169 P64
ALP170 P64 	ALP3030 P65 	ALP3030-T P66 	ALP6060-R P67 	ALP3880 P68
ALP051 P68 	ALP053-R P69 	ALP054-R1 P69 	ALP056 P70 	ALP056-D P70
ALP052 P71 	ALP057 P72 	ALP3875 P73 	ALP3875-D P73 	ALP5075-R P74

ALP5075-RD P74 	ALP7575-R P75 	ALP7575-RD P75 	ALP6875 P77 	ALP6875-D P77
ALP9575-R P79 	ALP9575-RD P79 	ALP10075-R P80 	ALP12575 P81 	ALP5090 P82
ALP6090 P82 	ALP7595-UP P84 	ALP60108 P84 	ALP049-R P85 	ALP12083 P86
ALP065 P87 	ALP065-T P87 	ALP066 P87 	T40 P88 	T60 P88
T100 P88 	ALP6545-C P90 	ALP5075-C P91 	ALP8585 P92 	ALP7575-RL P93
ALP100-WR P94 	ALP15023 P95 	ALP3875-R P96 	ALP38115 P97 	ALP5075-R1 P100
ALP50120 P101 	ALP6380 P103 	ALP63120 P104 	ALP7578 P106 	ALP75120 P108

ALP10078 P109 	ALP100120 P111 	ALP023-R2 P113 	ALP024 P114 	ALP024-R P115
ALP024-R1 P116 	SK1580-5 P117 	SK1580-10 P117 	SK1580-18 P117 	SK1580TR-5 P118
SK1580TR-10 P118 	SK1580TR-18 P118 	ALP068-S P119 	ALP068-R P119 	ALP069-R P120
ALP070-R P120 	ALP071 P123 	ALP079 P123 	ALP080 P124 	ALP081-R P124
ALP082 P125 	ALP083-R P125 	ALP085 P128 	ALP086 P128 	ALP087 P129
ALP088 P129 	ALP089 P129 	ALP090 P131 	ALP091-E P132 	ALP084 P133
ALP1084-S P133 	ALP3030-R P134 	ALP3030-R2 P134 	ALP092 P137 	ALP093 P138

<p>ALP094 P139</p>	<p>ALP095 P140</p>	<p>ALP110-S P141</p>	<p>ALP110-R P141</p>	<p>ALP111-S P142</p>
<p>ALP111-R P142</p>	<p>ALP118 P143</p>	<p>ALP078 P144</p>	<p>ALP078-R P144</p>	<p>ALP126 P146</p>
<p>ALP127 P146</p>	<p>ALP128 P147</p>	<p>ALP129 P148</p>	<p>ALP130 P148</p>	<p>ALP131 P149</p>
<p>ALP132 P149</p>	<p>ALP133 P149</p>	<p>ALP033 P150</p>	<p>ALP034 P150</p>	<p>S1018-S P151</p>
<p>S1616-T P151</p>	<p>S1616-S P152</p>	<p>S1616-C P152</p>	<p>S0410-S P153</p>	<p>S0612-S P153</p>
<p>S1010-T P154</p>	<p>S3021-T P154</p>	<p>S20 P155</p>	<p>LS30 P156</p>	<p>LS30-T P159</p>
<p>LS30-TS P159</p>	<p>LS40 P161</p>	<p>LS40-T P164</p>	<p>LS40-S P164</p>	<p>LS40-TS P165</p>

<p>LS50 P166</p>	<p>LS50-T P169</p>	<p>LS50-TS P169</p>	<p>LS50-T1 P170</p>	<p>LS50-U P170</p>
<p>ALP25C-R P172</p>	<p>ALP3050C P174</p>	<p>ALP50C P176</p>	<p>ALP30C P177</p>	<p>ALP30C0 P178</p>
<p>ALP1202 P179</p>	<p>ALP2002 P179</p>	<p>ALP2502 P179</p>	<p>HD5050 P180</p>	<p>RDB01 P181</p>
<p>RDB02 P181</p>				

Cabinet Lighting Series



ALP143

Black PC cover PC diffused cover			90° Vertical connector
End cap with hole End cap without hole			135° Connector
Spring clip			135° Vertical connector
90° Connector			180° Connector

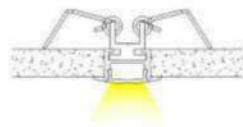
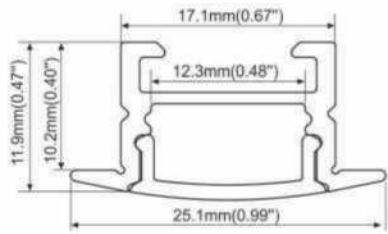

Cabinet Lighting Series



ALP145

Black PC cover PC diffused cover			90° Vertical connector
End cap with hole End cap without hole			135° Connector
Spring clip			135° Vertical connector
90° Connector			180° Connector

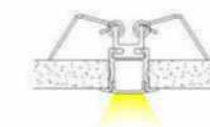
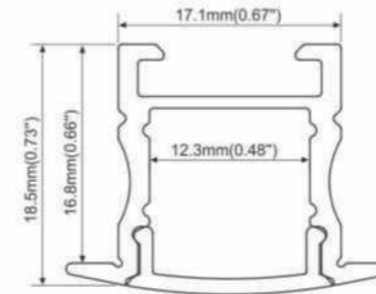

ALP144

Black PC cover PC diffused cover			90° Connector
End cap with hole End cap without hole			90° Vertical connector
Mounting clip(metal)			135° Connector
Magnet			135° Vertical connector
Adjustable bracket			180° Connector

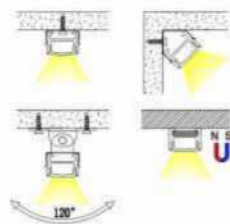
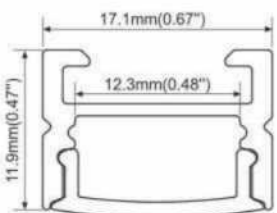

ALP146

Black PC cover PC diffused cover			90° Connector
End cap with hole End cap without hole			90° Vertical connector
Mounting clip(metal)			135° Connector
Magnet			135° Vertical connector
Adjustable bracket			180° Connector

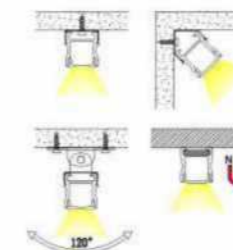
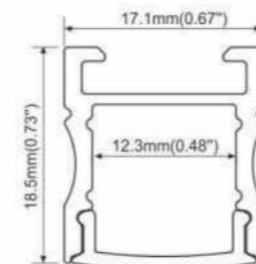

ALP001-R

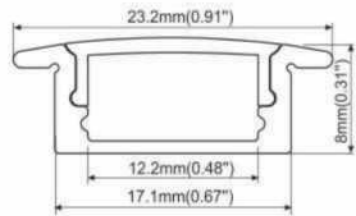

End cap with hole
End cap without hole



PMMA opal matte cover
PMMA semi-clear cover
PMMA clear cover
PC diffused cover



Black PC cover



Step 01

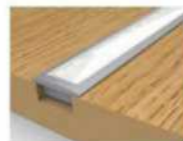

Step 04



Step 02



Step 03



ALP002-R

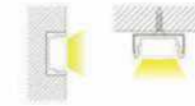
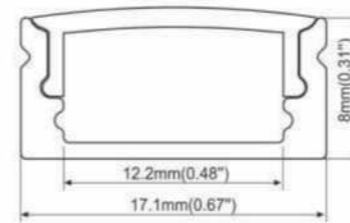

- PMMA opal matte cover
- PMMA semi-clear cover
- PMMA clear cover
- PC diffused cover

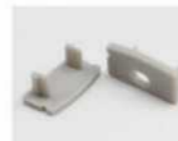

End cap with hole
End cap without hole



Black PC cover



Adjustable bracket



Mounting clip(PC)

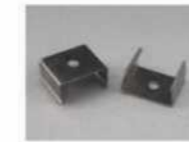

Mounting clip(metal)



90° Connector



180° Connector



ALP002-RL

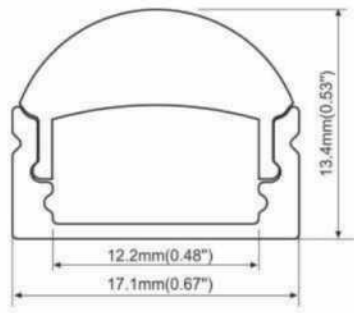

PMMA opal matte cover
PMMA semi-clear cover
PMMA clear cover
60 degrees



End cap with hole
End cap without hole



Mounting clip(PC)

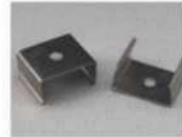

Mounting clip(metal)



90° Connector



180° Connector



ALP004-RL

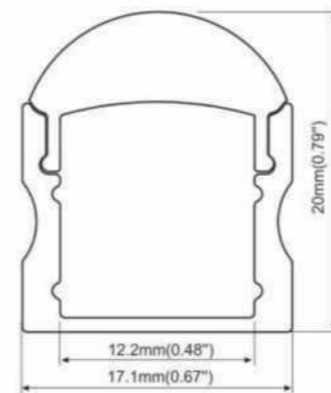

PMMA opal matte cover
PMMA semi-clear cover
PMMA clear cover
15 degrees



End cap with hole
End cap without hole



Mounting clip(metal)



Mounting clip(PC)



90° Connector



180° Connector

ALP003-R

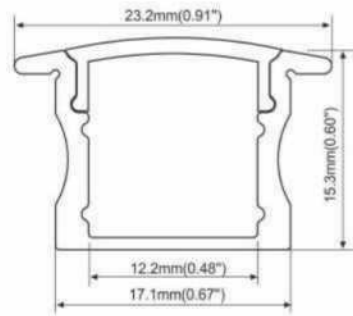

- PMMA opal matte cover
- PMMA semi-clear cover
- PMMA clear cover
- PC diffused cover



End cap with hole
End cap without hole



Step 01

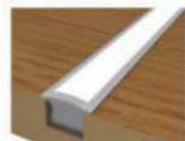

Step 02

ALP004-R

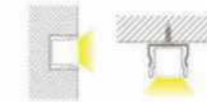
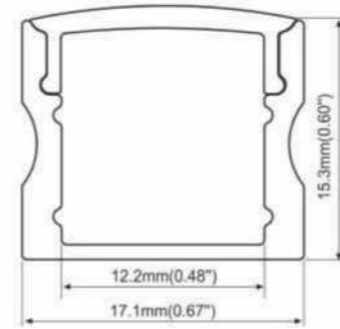

- PMMA opal matte cover
- PMMA semi-clear cover
- PMMA clear cover
- PC diffused cover



End cap with hole
End cap without hole



90° Connector



180° Connector



Mounting clip(metal)



Mounting clip(PC)



Adjustable bracket



Step 01



Step 04



Step 02



Step 05



Step 03

ALP005

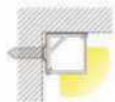
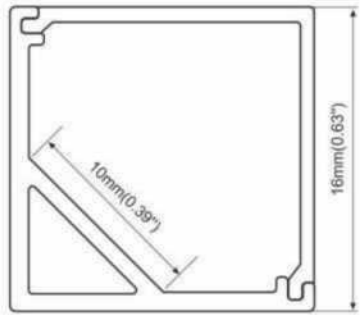

- PMMA opal matte cover
- PMMA semi-clear cover
- PC diffused cover



End cap with hole
End cap without hole



Mounting clip(PC)



Mounting clip(metal)



Step 01



Step 02



Step 03



Step 04

ALP006

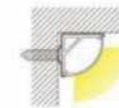
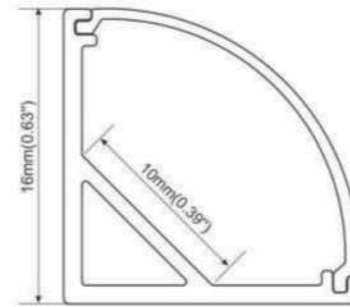

- PMMA opal matte cover
- PMMA semi-clear cover
- PC diffused cover



End cap with hole
End cap without hole



Mounting clip(metal)



Mounting clip(PC)



ALP007-R

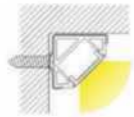
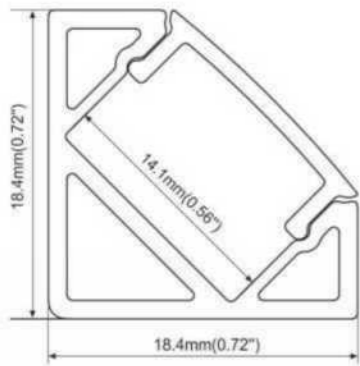

- PMMA opal matte cover
- PMMA semi-clear cover
- PMMA clear cover
- PC diffused cover



End cap with hole
End cap without hole



Mounting clip(metal)



Mounting clip(PC)

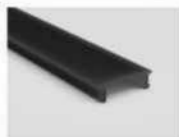

Black PC cover



Step 01

Step 04



Step 02

Step 05

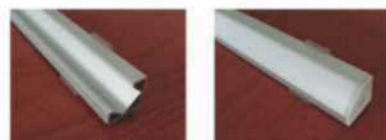

Step 03

Step 06

ALP008

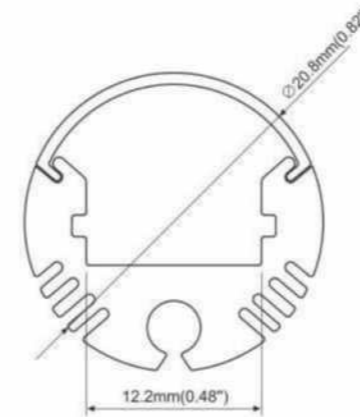

- PMMA opal matte cover
- PMMA semi-clear cover
- PC diffused cover



End cap with hole
End cap without hole



Mounting clip(metal)



Steel wire



Step 01



Step 04



Step 02



Step 05



Step 03



Step 06

ALP010

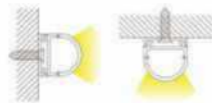
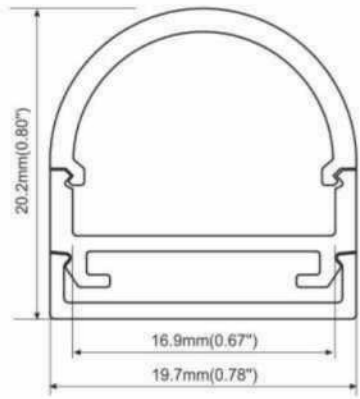

- PMMA opal matte cover
- PMMA semi-clear cover
- PC diffused cover



End cap with hole
End cap without hole



Step 01



Step 04

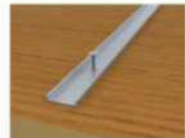

Step 02



Step 05



Step 03



Step 06

ALP011

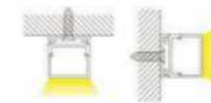
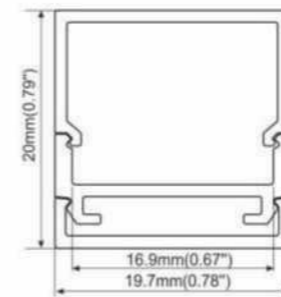

- PMMA opal matte cover
- PMMA semi-clear cover
- PC diffused cover

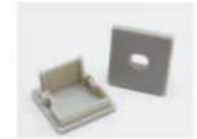

End cap with hole
End cap without hole

ALP012

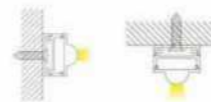
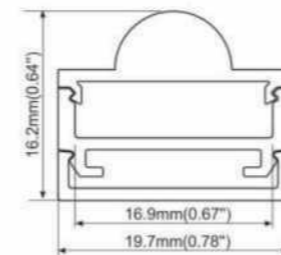

- PMMA clear cover



End cap with hole
End cap without hole



ALP027

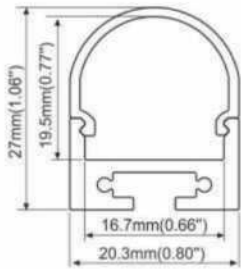

- PMMA opal matte cover
- PMMA semi-clear cover
- PC diffused cover



ALP028

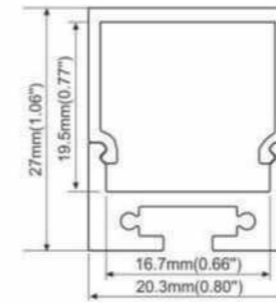

- PMMA opal matte cover
- PMMA semi-clear cover
- PC diffused cover



ALP029

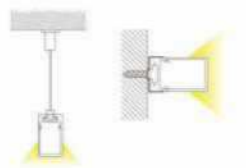
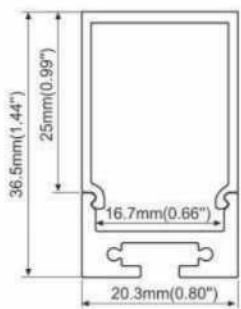

- PC diffused cover



ALP013-R

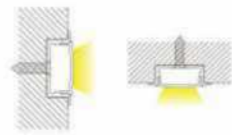
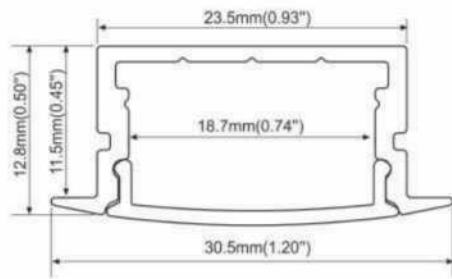

- PMMA opal matte cover
- PMMA semi-clear cover
- PMMA clear cover
- PC diffused cover



End caps



Black PC cover



Spring clip



Metal clip

ALP014-R

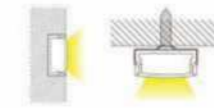
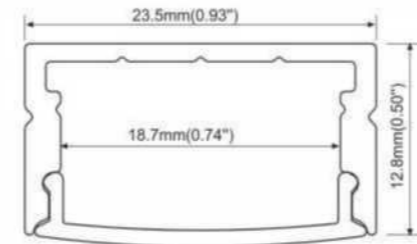

- PMMA opal matte cover
- PMMA semi-clear cover
- PMMA clear cover
- PC diffused cover



End cap with hole
End cap without hole



Adjustable bracket



Mounting clip(PC)



Black PC cover



Mounting clip(metal)



ALP013

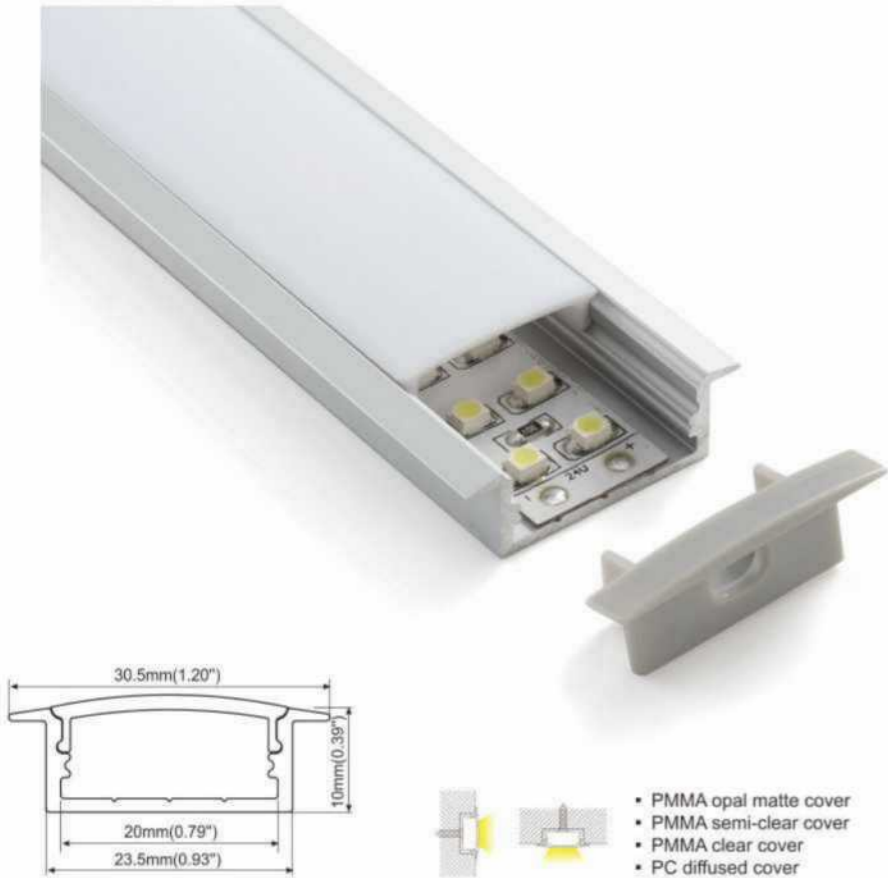

ALP031

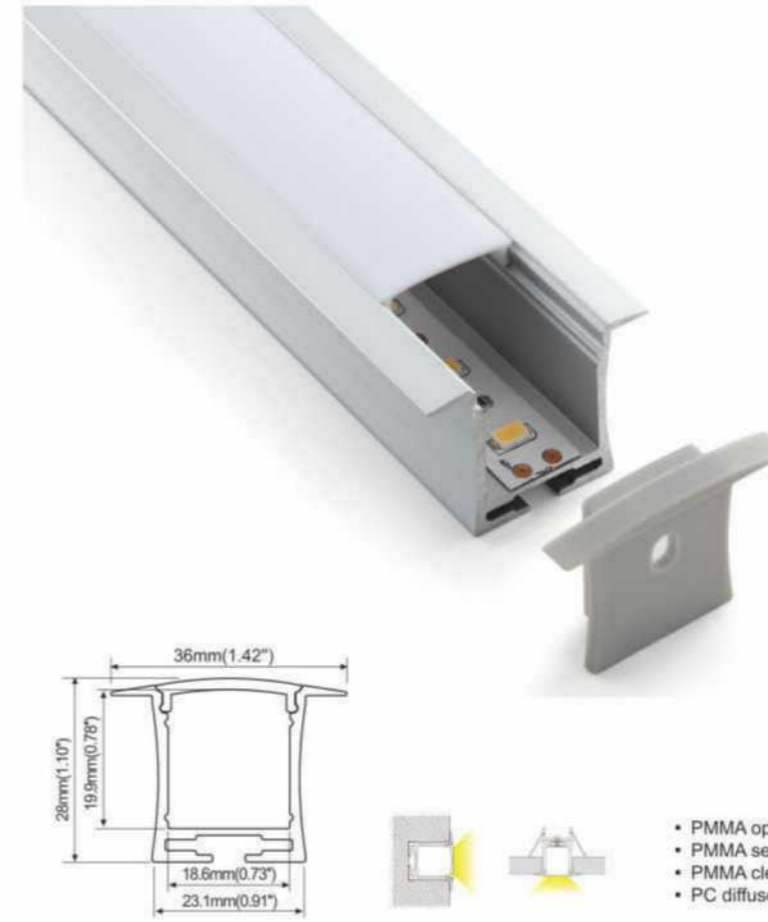

ALP014



ALP032

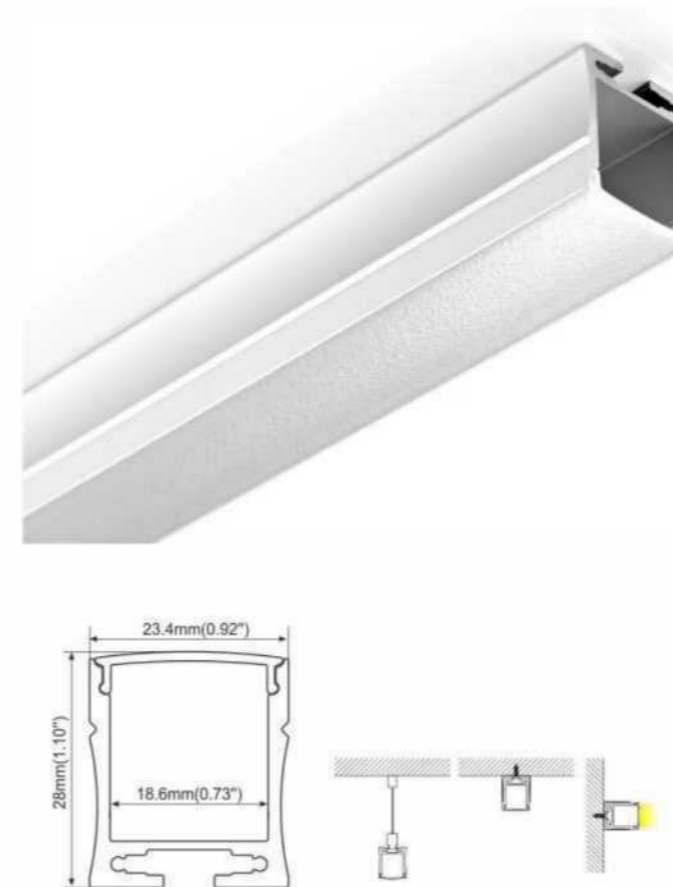

ALP015-R

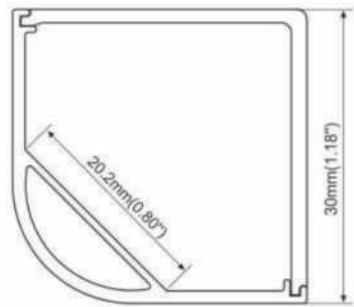

- PMMA opal matte cover
- PMMA semi-clear cover



End cap with hole
End cap without hole



Mounting clip(metal)

ALP016-R

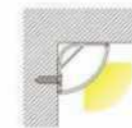
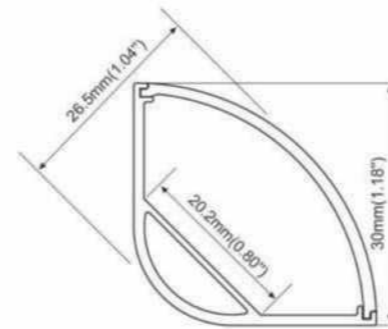

- PMMA opal matte cover
- PMMA semi-clear cover
- PC diffused cover



End cap with hole
End cap without hole



Mounting clip(metal)



90° Inside connector



157° Outside connector



90° Joining connector



180° Joining connector



Step 01



Step 02



Step 03



Step 04

ALP021

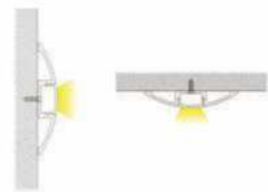
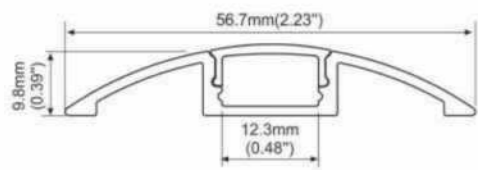

- PMMA opal matte cover
- PMMA semi-clear cover
- PMMA clear cover
- PC diffused cover



End cap with hole
End cap without hole

ALP077

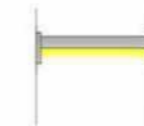
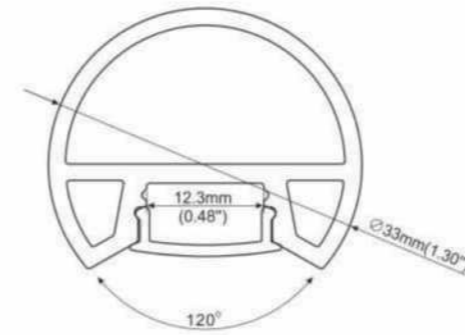

- PMMA opal matte cover
- PMMA semi-clear cover
- PMMA clear cover
- PC diffused cover



End caps

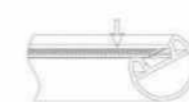

Step 01:
Stick led strip



Step 02:
Push the diffuser inside



Step 03:
Lock the end caps
inside the cabinet



Step 04:
Slide the cover plates

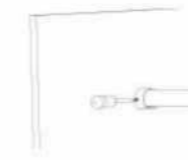

Step 05:
Fix the Aluminium profile



Step 06:
Installation completed



ALP043

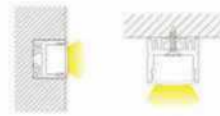
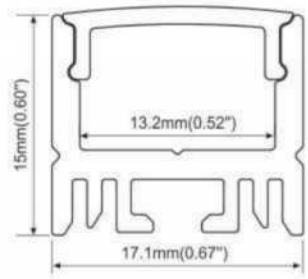

- PMMA opal matte cover
- PMMA semi-clear cover
- PMMA clear cover
- PC diffused cover



ALP044

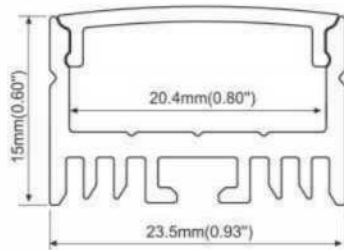

- PMMA opal matte cover
- PMMA semi-clear cover
- PMMA clear cover
- PC diffused cover



ALP044-PC-R

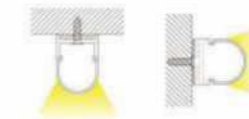
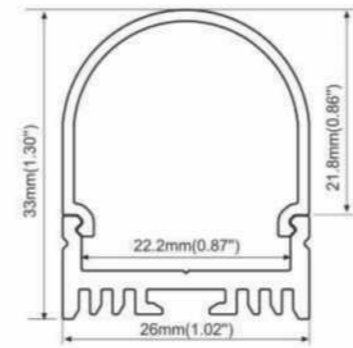

- PC diffused cover

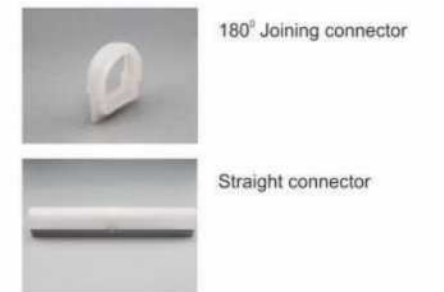
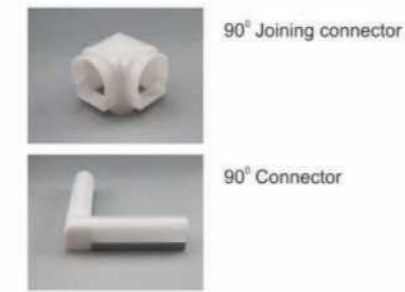

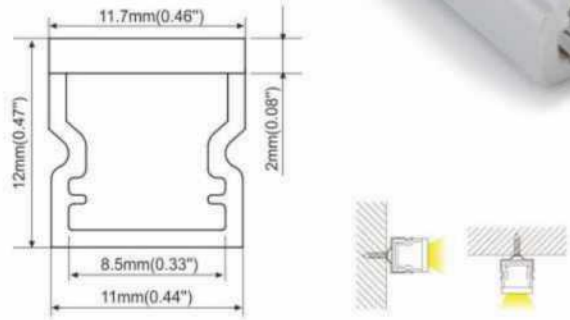

ALP025



End cap with hole
End cap without hole



Mounting clip(metal)



Rigid LED light bar

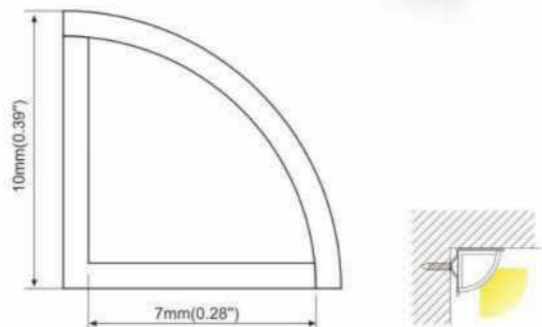

ALP026



End cap with hole
End cap without hole



Mounting clip(metal)



Rigid LED light bar

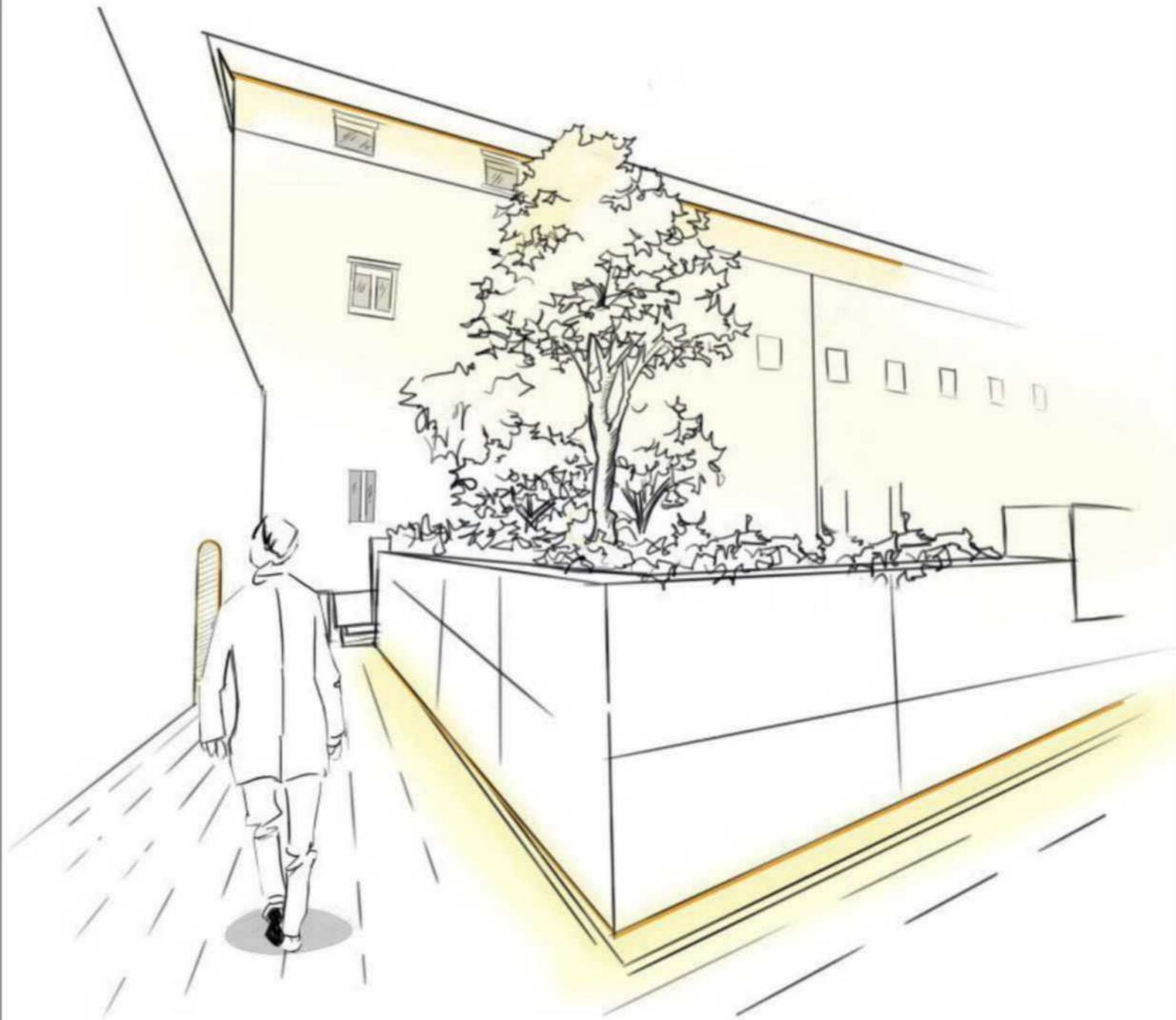

ALP073

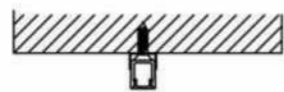
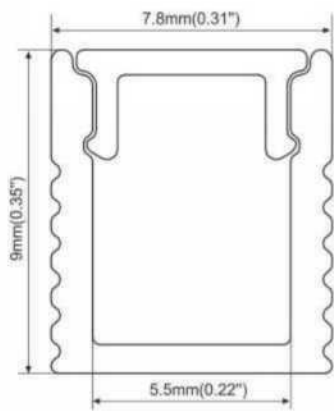
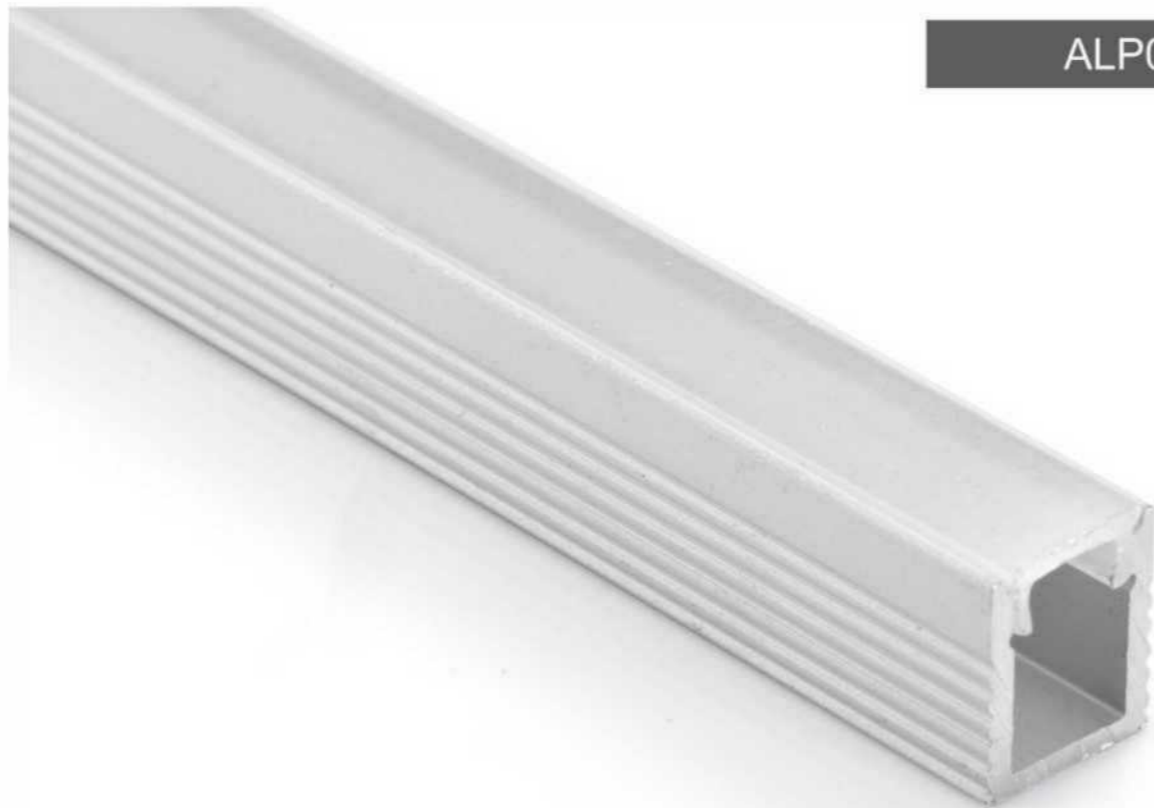

• PC frosted cover



End cap with hole
End cap without hole



Mounting clip(metal)



Black PC cover

ALP096

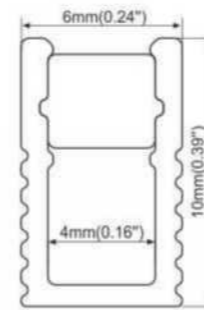

• Silicon cover



End cap with hole
End cap without hole

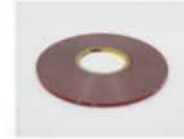

3M tape 5mm wide

ALP097

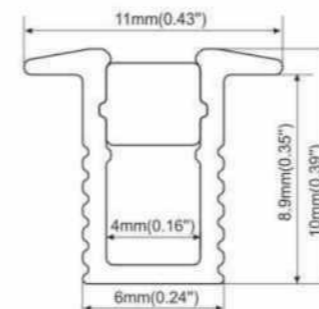

• Silicon cover



End cap with hole
End cap without hole

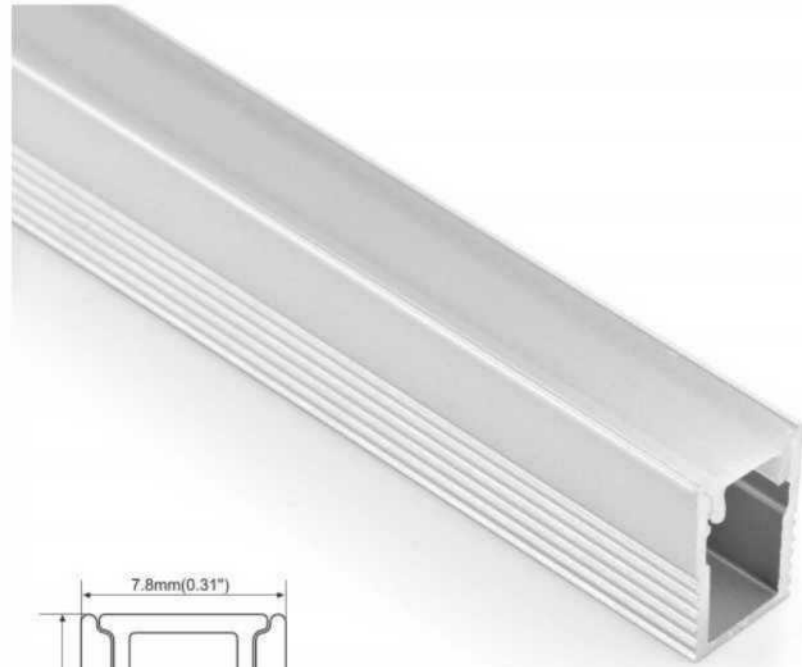

ALP116

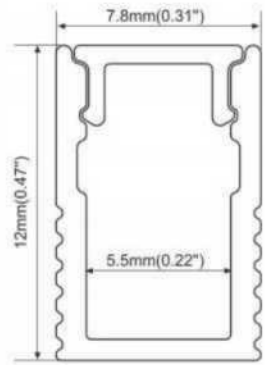

• PC frosted cover



ALP117

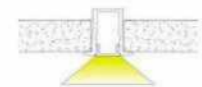
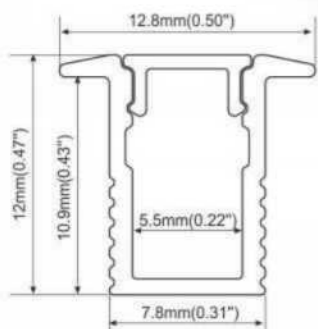

• PC frosted cover

ALP116

Installation methods



Step 01A

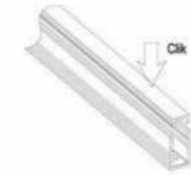

Step 02A



Step 01B



Step 02B



Step 03B



Step 03A



Step 04A



Step 04B



Step 05B



Step 05A



Step 06A



Step 06B



Step 07B

ALP117

Installation methods



Step 01



Step 02



Step 03



Step 04



Step 05



Step 06



Step 07

ALP035-R

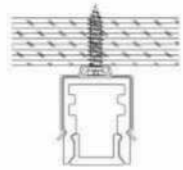
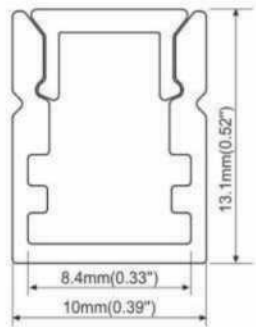

• PMMA diffused cover



End cap



Mounting clip(metal)



Black PC cover

ALP035-RL

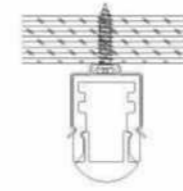
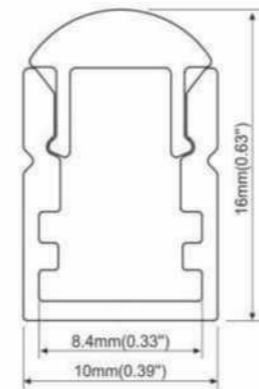

• PMMA forsted, 15 degrees



End cap with hole



End cap without hole



Mounting clip(metal)

ALP119

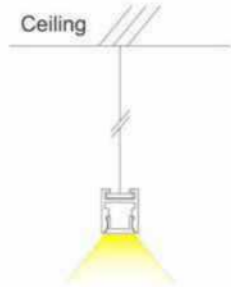
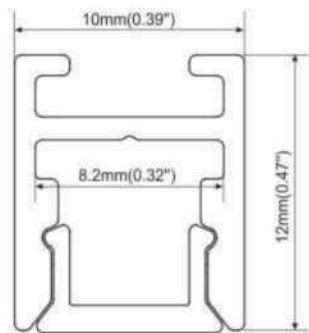

• Black PC cover

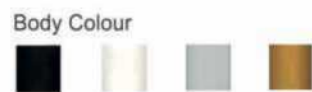

ALP140

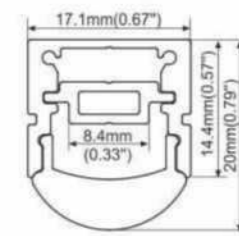
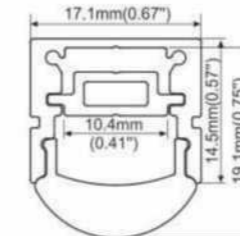
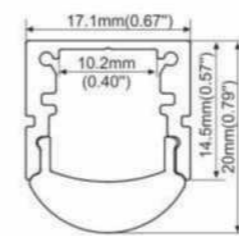

ALP100

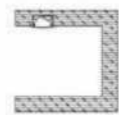
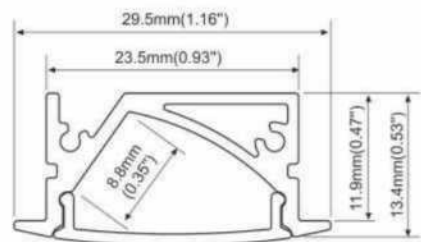
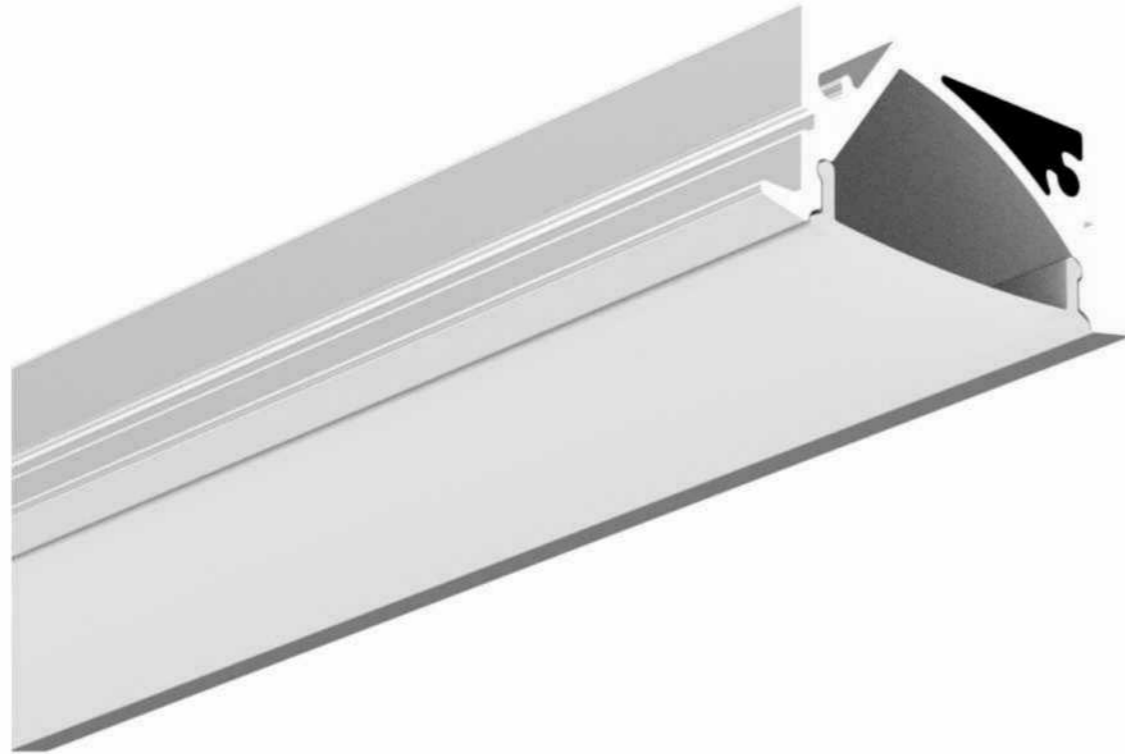

- PMMA opal matte cover
- PMMA semi-clear cover
- PC diffused cover



End caps



Spring clip

ALP099

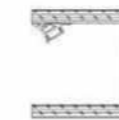
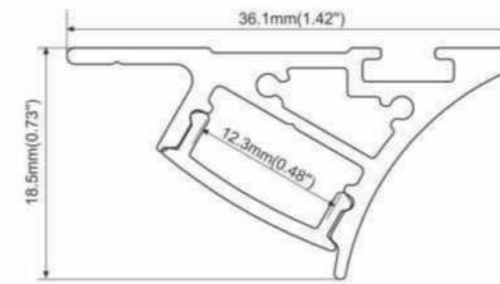

- PMMA opal matte cover
- PMMA semi-clear cover
- PC diffused cover



End cap with hole
End cap without hole

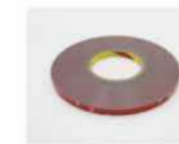

3M tape 10mm wide

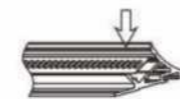

Step 01A

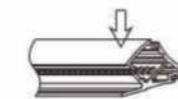

Step 02A



Step 03A



Step 04A

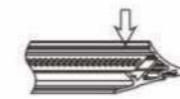

Step 01B



Step 03B



Step 05B

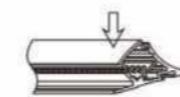

Step 02B



Step 04B



Step 06B

ALP039



16.2mm(0.64")
13mm(0.51")
18mm(0.71")



Aluminum profile



PMMA opal matte cover
PMMA semi clear cover



ALP039-30



15mm(0.60")
13mm(0.51")
18mm(0.71")



Aluminum profile



30 degrees lens
PMMA semi clear



ALP039-60



15.3mm(0.60")
13mm(0.51")
18mm(0.71")



Aluminum profile



60 degrees lens
PMMA semi clear



ALP039-90



13.5mm(0.53")
13mm(0.51")
18mm(0.71")



Aluminum profile



90 degrees lens
PMMA semi clear



ALP040



23.5mm(0.93")
13mm(0.51")
18mm(0.71")



Aluminum profile



PMMA opal matte cover
PMMA semi clear cover



ALP040-30



22.2mm(0.87")
13mm(0.51")
18mm(0.71")



Aluminum profile



30 degrees lens
PMMA semi clear



ALP040-60



22.2mm(0.87")
13mm(0.51")
18mm(0.71")



Aluminum profile



60 degrees lens
PMMA semi clear



ALP040-90



21mm(0.83")
13mm(0.51")
18mm(0.71")





Aluminum profile



90 degrees lens
PMMA semi clear



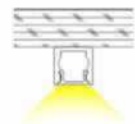
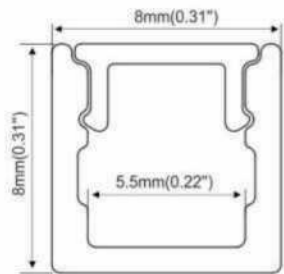

ALP134

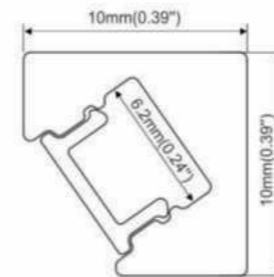

• PC frosted cover

ALP136



• PC frosted cover

ALP135

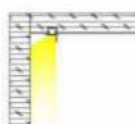
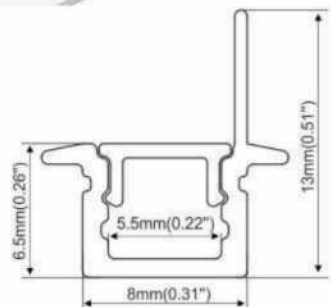

• PC frosted cover

ALP137

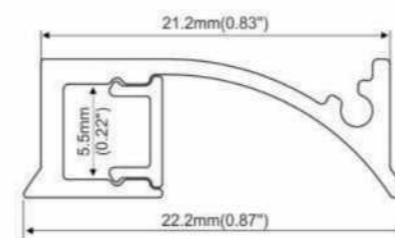

• PC frosted cover



ALP138

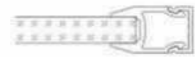
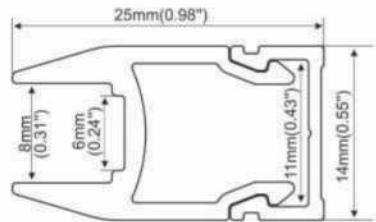

• PC diffused cover



ALP139

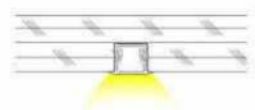
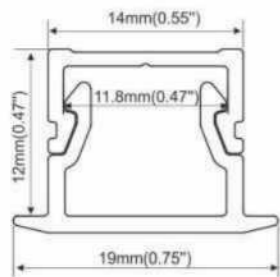

• PC diffused cover



ALP180

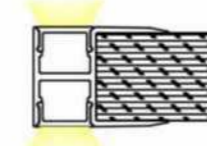
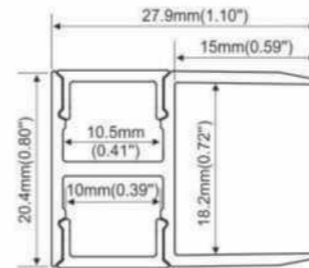
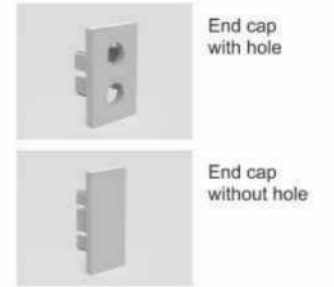

• PC diffused cover



ALP181

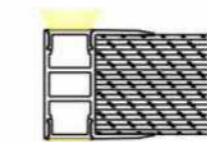
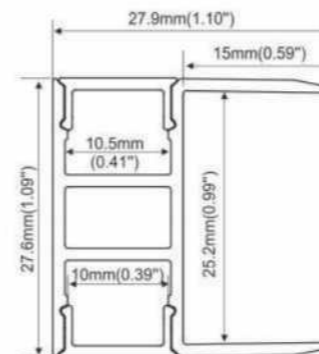



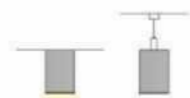
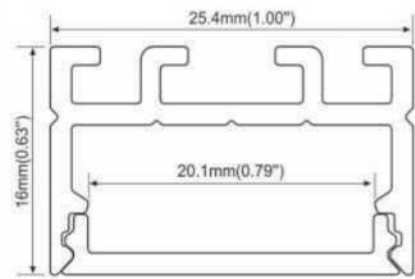

• PC diffused cover



• PC diffused cover

ALP109

-  End caps
-  Clip
-  90 degrees connector
-  120 degrees connector
-  180 degrees connector

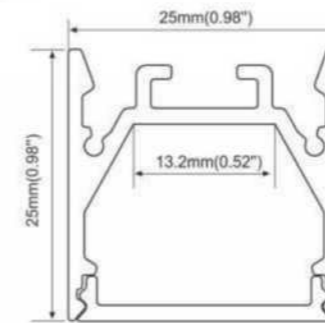
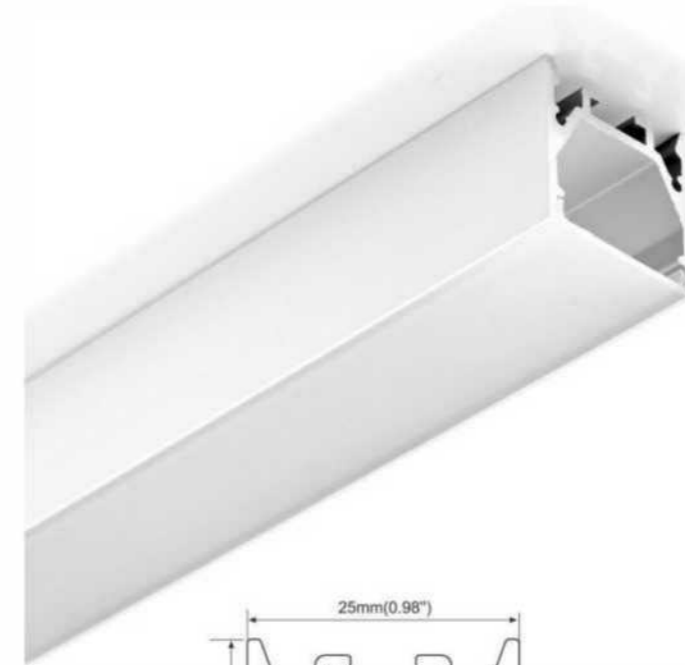

• PC diffused cover

ALP104

-  End caps
-  Clip
-  Steel wire

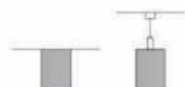
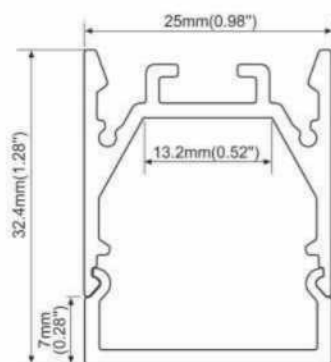

• PC diffused cover

ALP106

-  End caps
-  Clip
-  Steel wire
-  90 degrees connector
-  180 degrees connector

ALP105

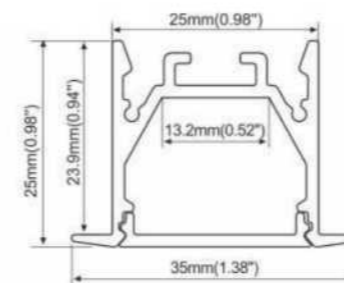

• PC diffused cover

-  End caps
-  Spring clip

ALP107

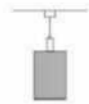
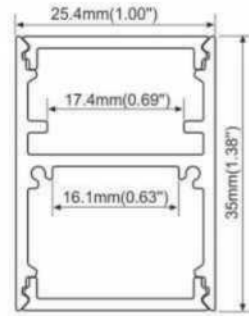
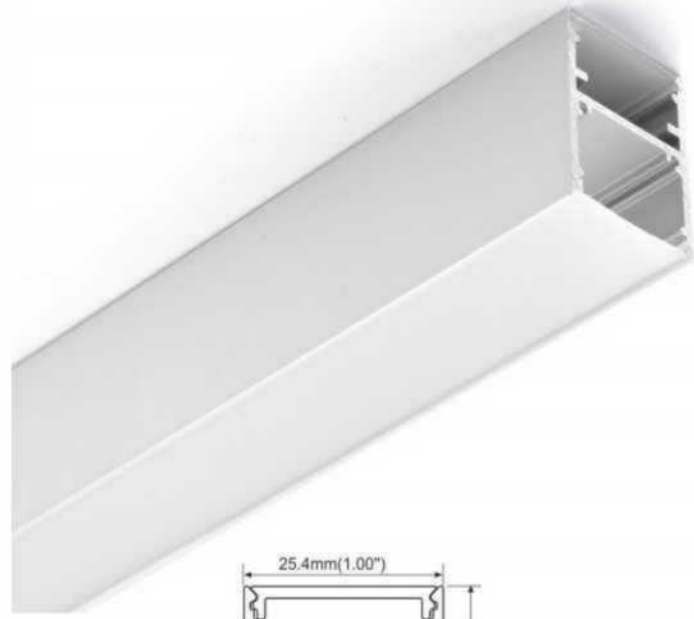

• PC diffused cover



End caps



Hanging clip



Steel wire

ALP017-R

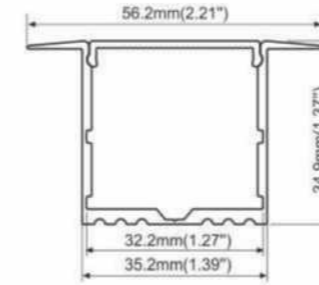

• PMMA opal matte cover
• PMMA semi-clear cover
• PC diffused cover

End cap with hole
End cap without hole

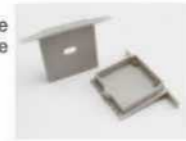

Step 01

Mounting clip



Step 02



Step 03

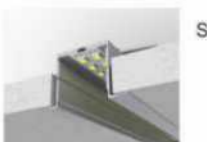

Step 04

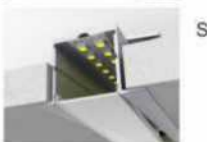

Step 05



Step 06

ALP108

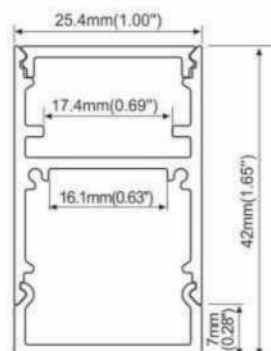

• PC diffused cover



End caps



Hanging clip



Steel wire

ALP018

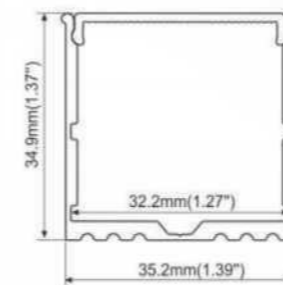
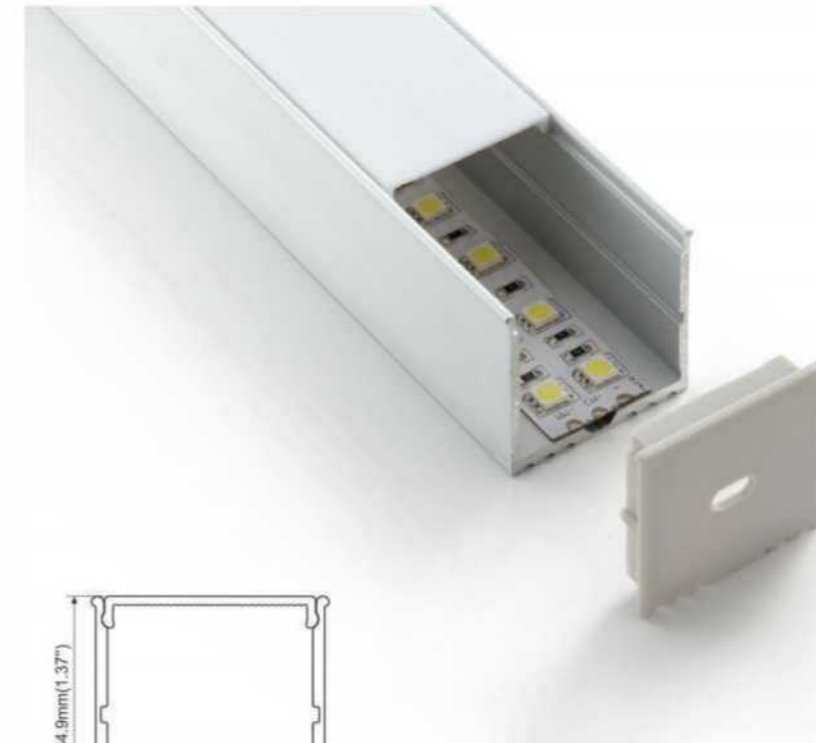

• PMMA opal matte cover
• PMMA semi-clear cover
• PC diffused cover



End caps



ALP045

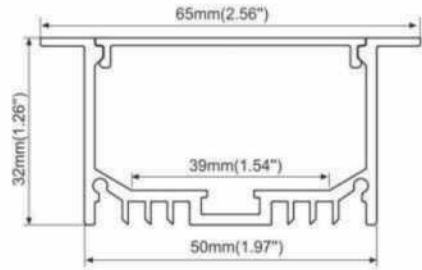

• PC diffused cover



ALP046

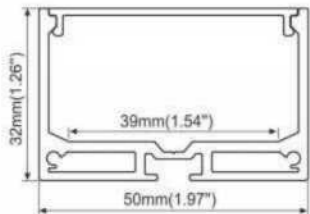

• PC diffused cover



ALP047

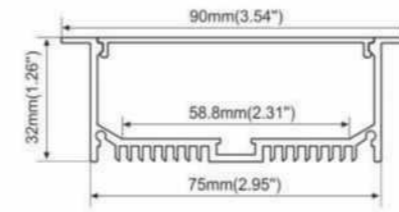

• PC diffused cover



ALP048

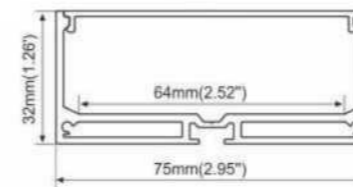

• PC diffused cover

ALP017-R5

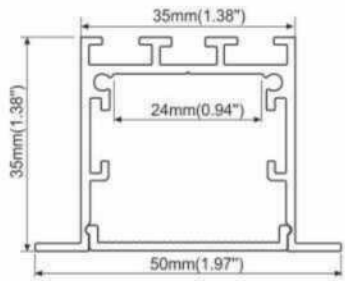

- PMMA opal matte cover
- PMMA semi-clear cover
- PC diffused cover



Aluminium End Cap without hole



Connector T



Connector X



Connector IL



Spring clip

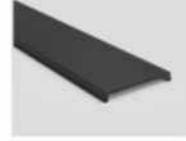

Black PC cover

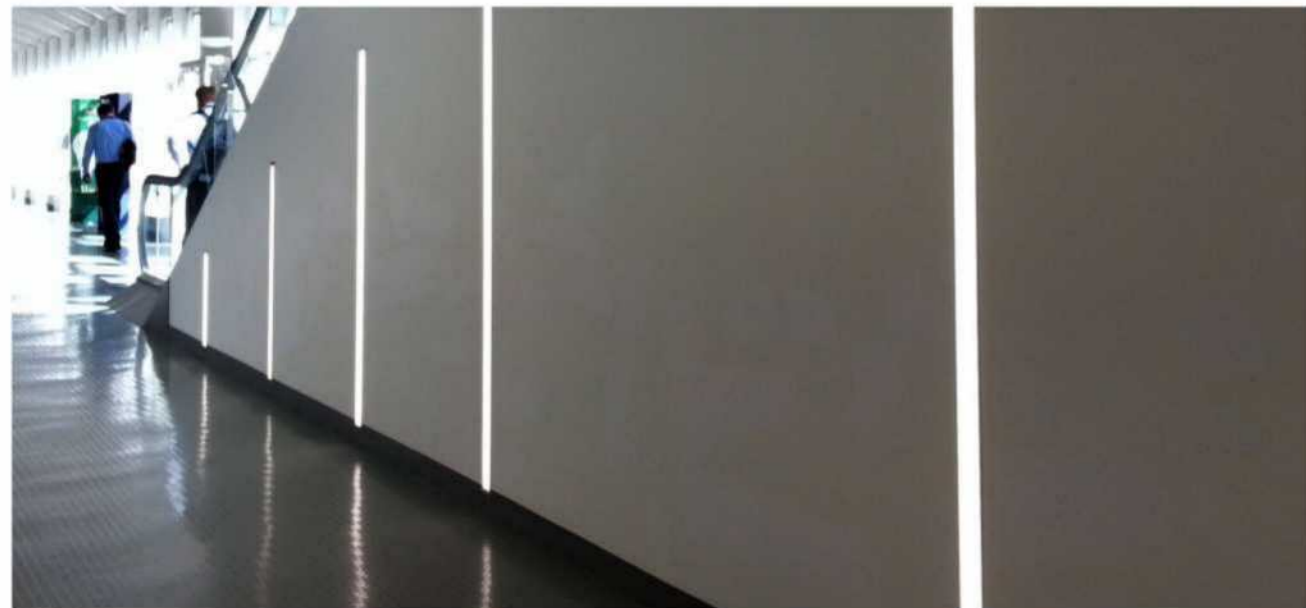

ALP018-R3

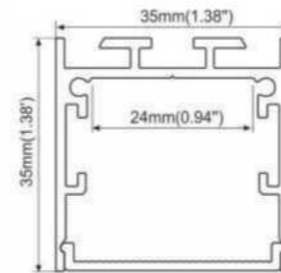
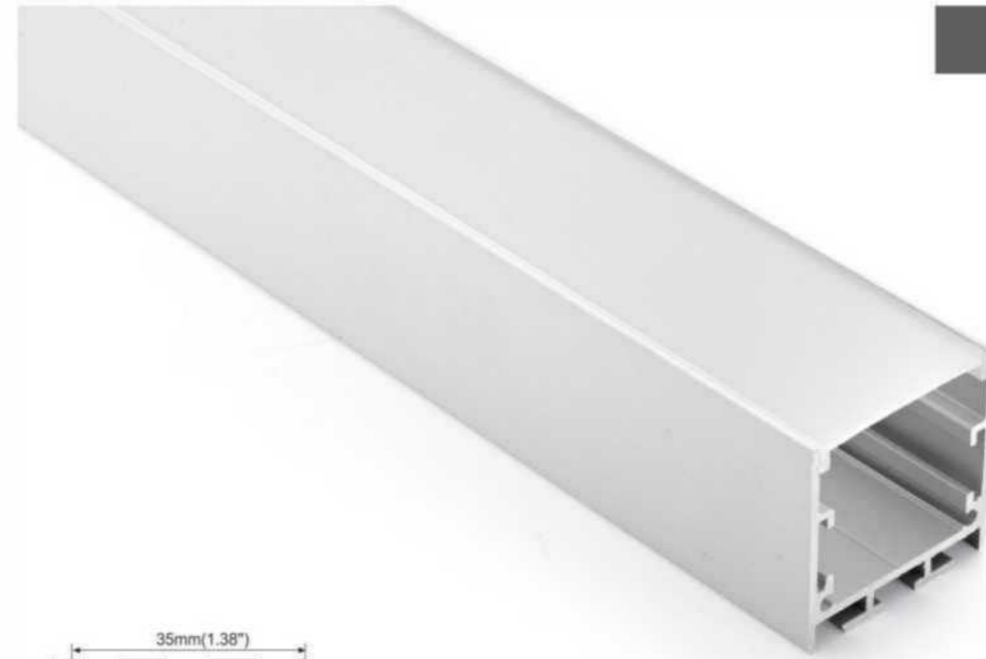

- PMMA opal matte cover
- PMMA semi-clear cover
- PC diffused cover



Aluminium End Cap without hole



Mounting clip(metal)



Connector L



Steel wire



Connector T



Connector X



ALP045-R

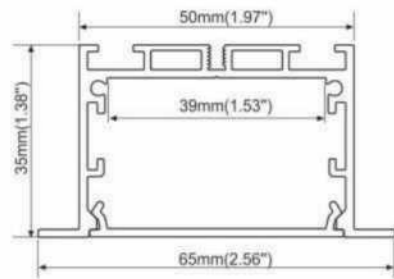

• PC diffused cover



Aluminium End Cap without hole



Stainless Clip



Connector T



Connector L



Connector X



Connector IL

ALP046-R

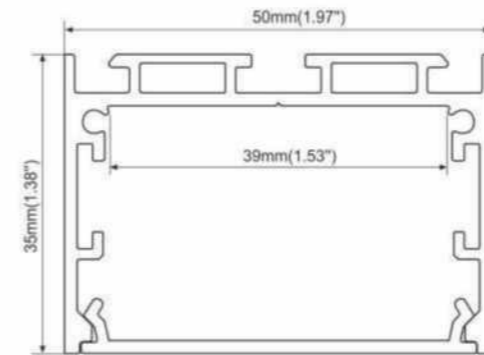

• PC diffused cover



Aluminium End Cap without hole



Steel wire



Stainless Clip



Connector X



Connector T



Connector L



Connector IL



90 degrees



180° Connector



Inside 90° Connector

ALP047-R1

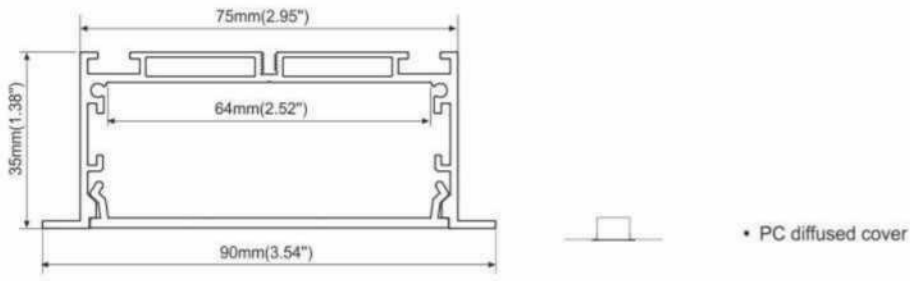

ALP048-R1

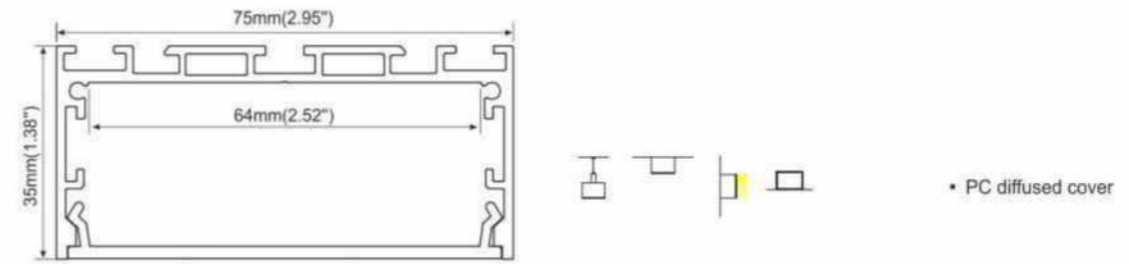

Decorative Lighting Series

ALP6535



Aluminium End Cap without hole



Connector T

Stainless Clip



Connector L

LED Module: 2835LED 28W/1.2M

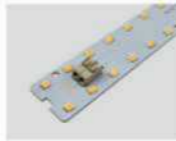

Connector X



Connector IL

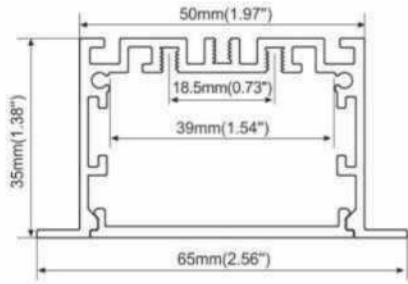

• PC frosted cover

Decorative Lighting Series

ALP9035



Aluminium End Cap without hole



Connector T

Stainless Clip



Connector L

LED Module: 2835LED 42W/1.2M

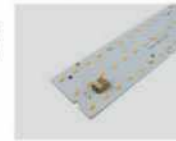

Connector X



Connector IL

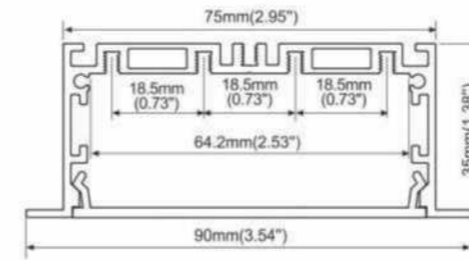

• PC frosted cover

ALP5035



Aluminium End Cap without hole



Connector T

Stainless Clip



Connector L

Steel wire



Connector X

LED Module: 2835LED 28W/1.2M

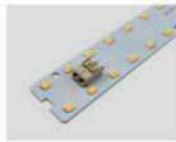

Connector IL

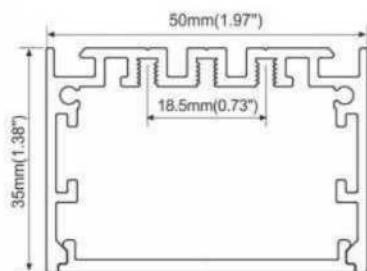

• PC frosted cover

ALP7535



Aluminium End Cap without hole



Connector T

Stainless Clip



Connector L

Steel wire



Connector X

LED Module: 2835LED 42W/1.2M



Connector IL

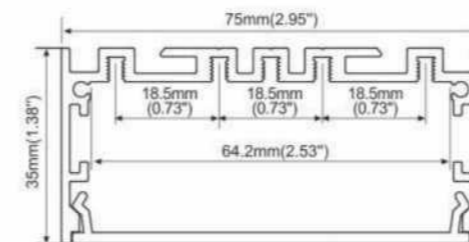

• PC frosted cover

ALP12335

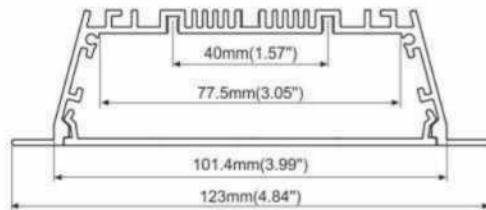

• PC frosted cover



Aluminium End Cap without hole



Connector T



Connector X



Stainless Clip



Connector L



Connector IL



ALP059-R

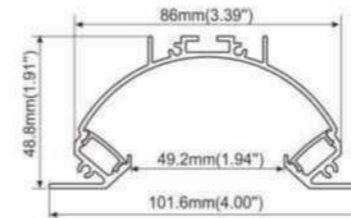

• PMMA semi-clear cover



Aluminium end cap



Spring Clip



Step 01: Stick flex led strip inside the profile



Step 05: Fix end caps



Step 02: Push the diffuser



Step 03: Slide the spring clip on the back



Step 06: Recessed the profile into the ceiling



Step 04: Fix spring clip



Step 07: Installation completed

ALP114

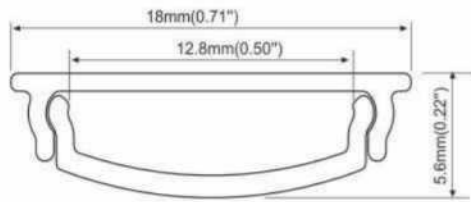
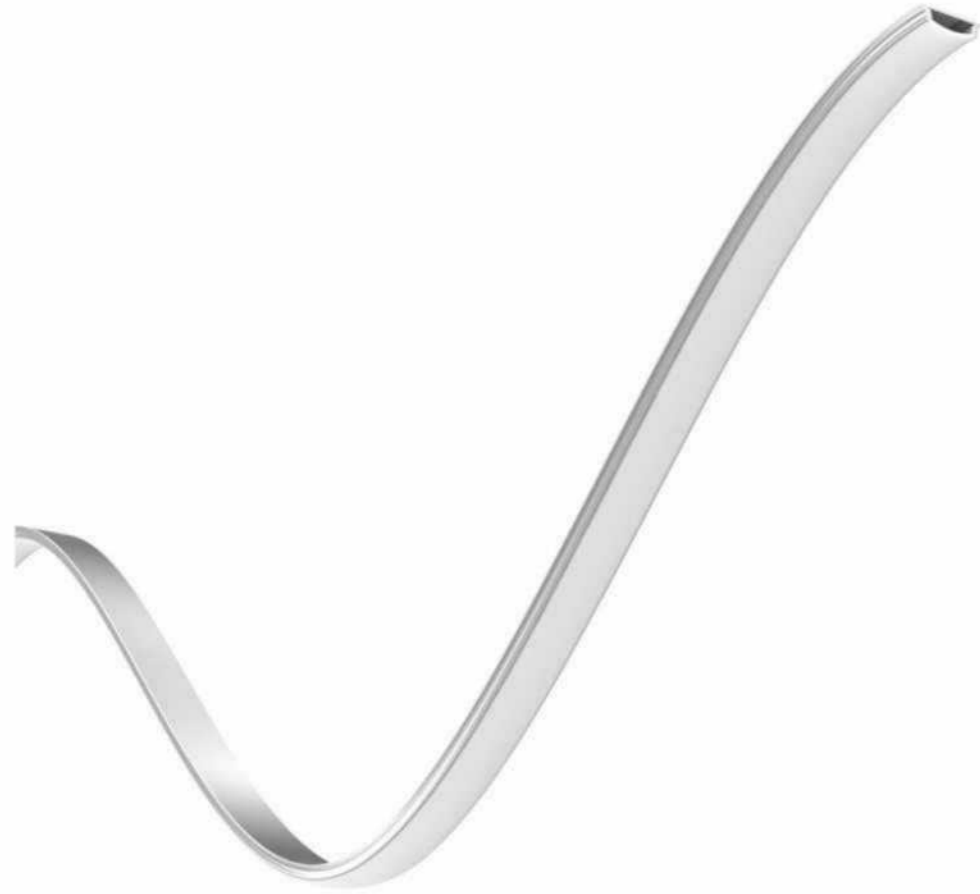

• PC diffused cover



End caps



Clip



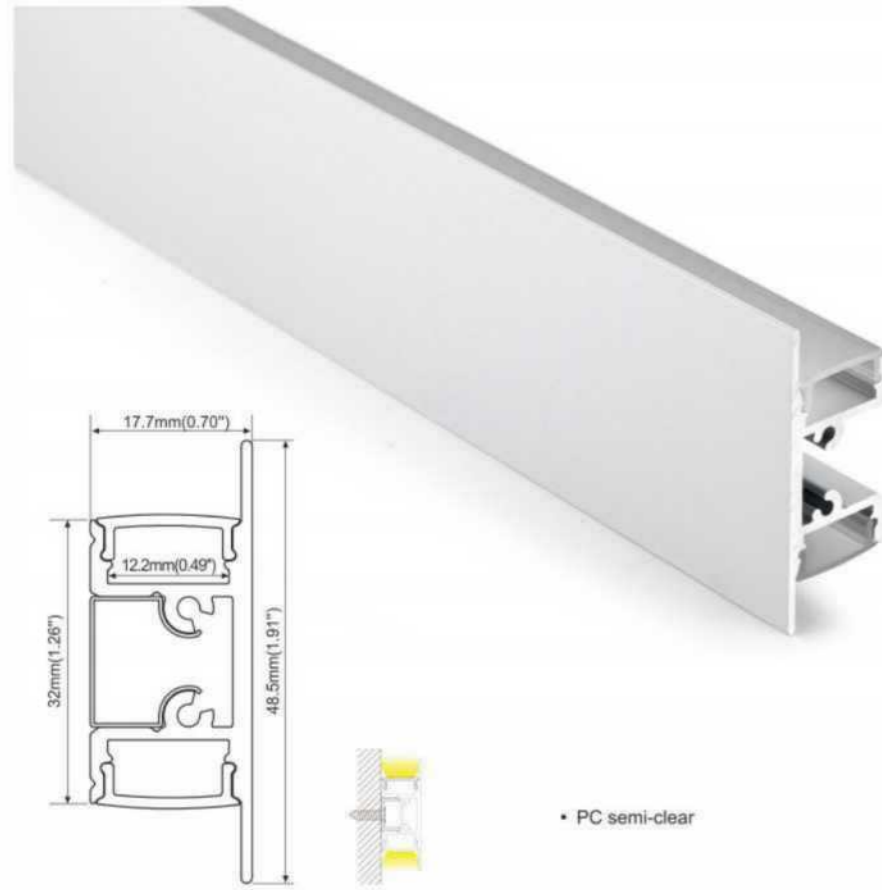

ALP050



• PC semi-clear

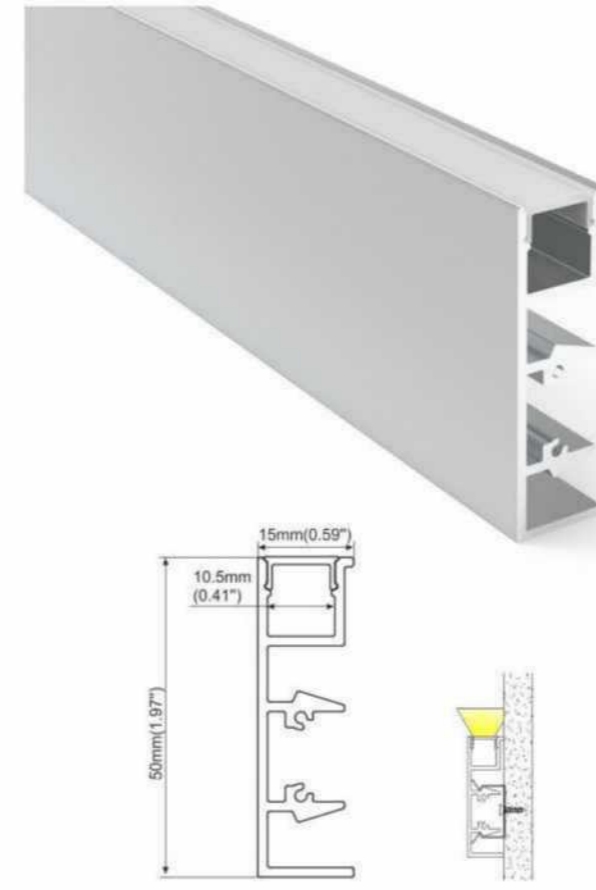

ALP169



ALP062



• PC semi-clear

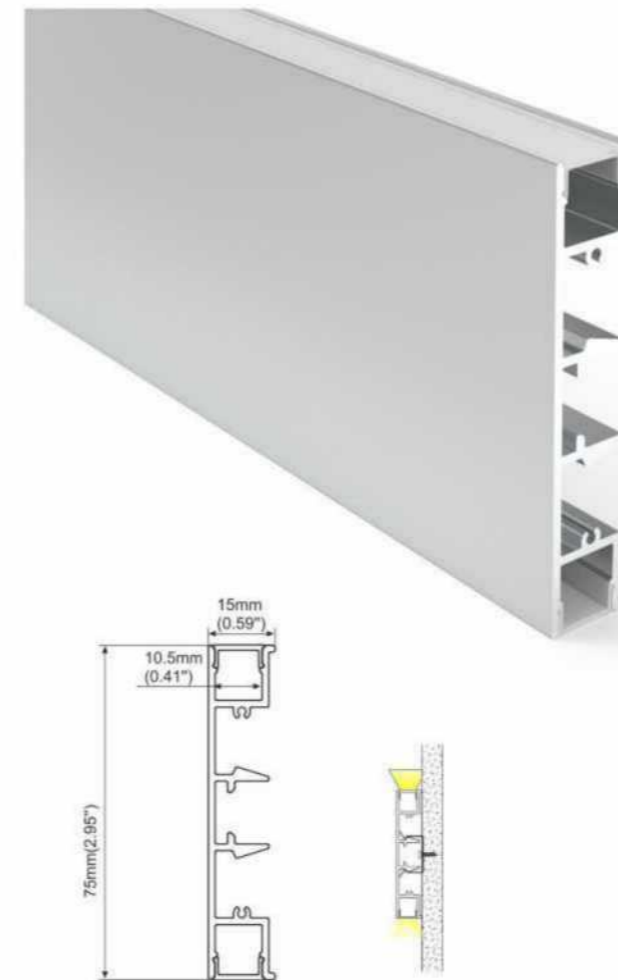

ALP170



ALP3030

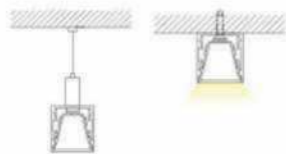
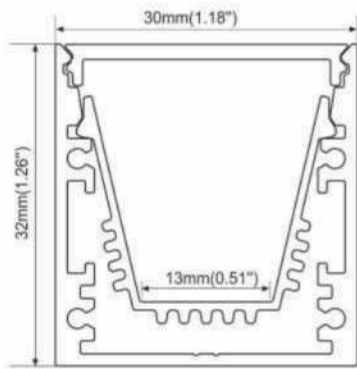

• PC frosted cover



End cap without hole



90° Connector



Inside 90° Connector



Steel wire



180° Connector

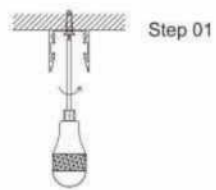

Step 01

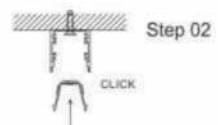

Step 02

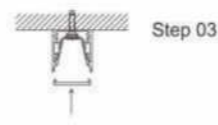

Step 03



Step 04

ALP3030-T

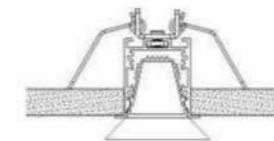
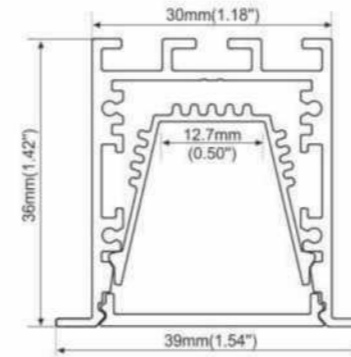
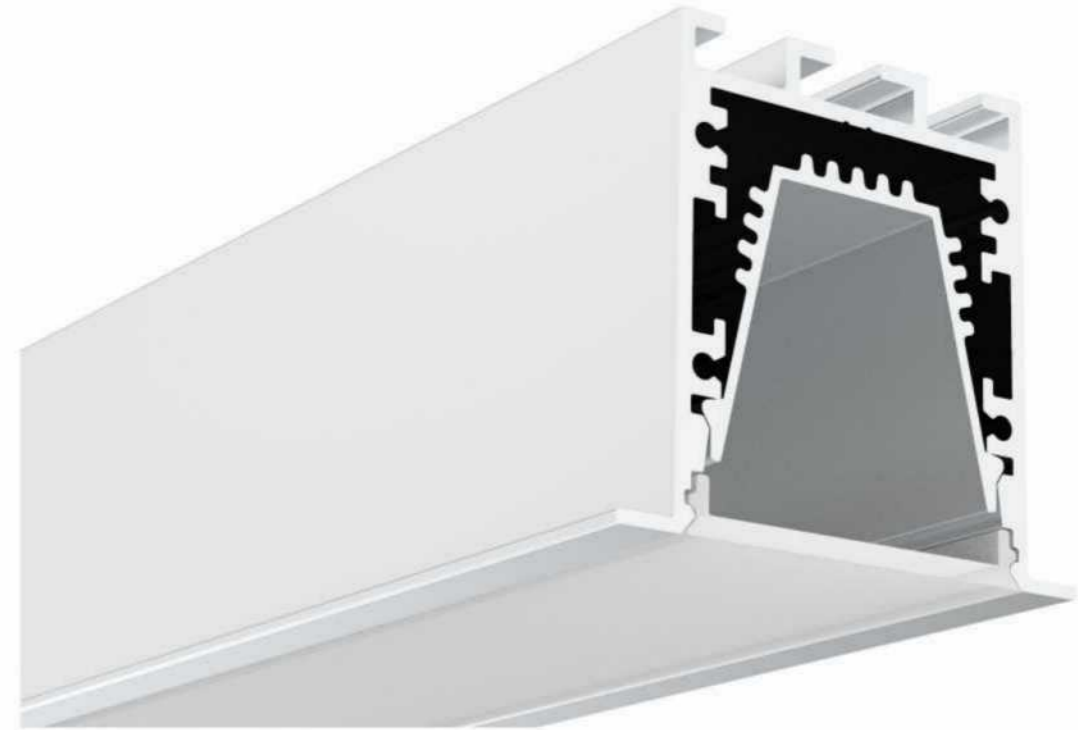

PC frosted cover



90° Connector



End cap without hole



90° Vertical connector



Spring clip



180° Connector

ALP6060-R

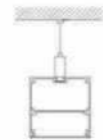
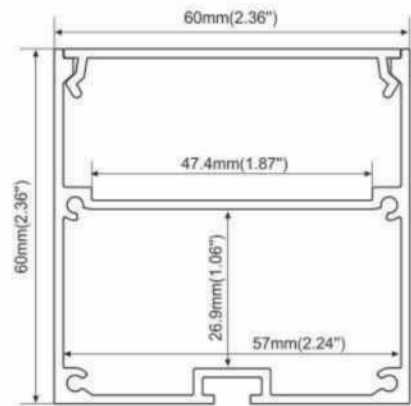

• PC frosted cover



End cap without hole



Steel wire

ALP3880



• PC frosted cover



End cap without hole



Steel wire

ALP051

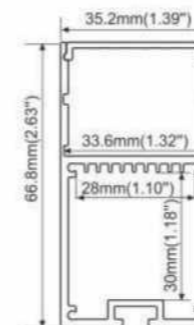
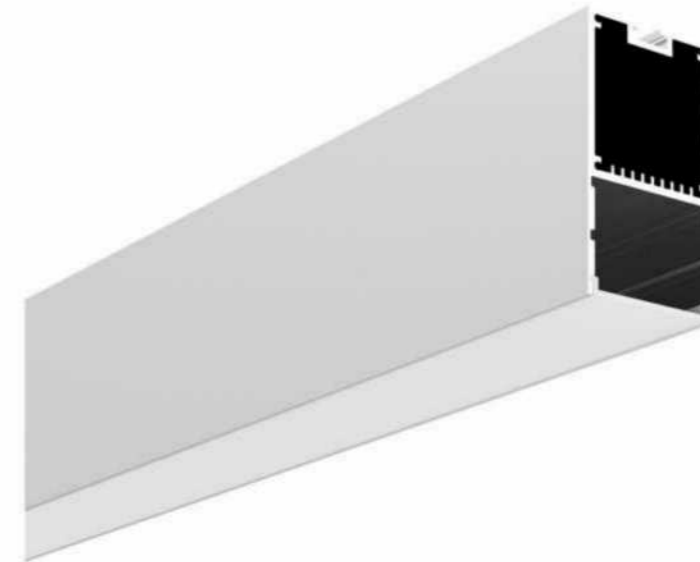

• PMMA opal matte cover
• PMMA semi-clear cover
• PC diffused cover



End caps



Steel wire

ALP053-R

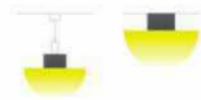
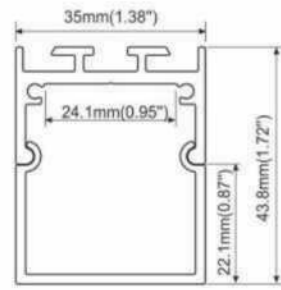
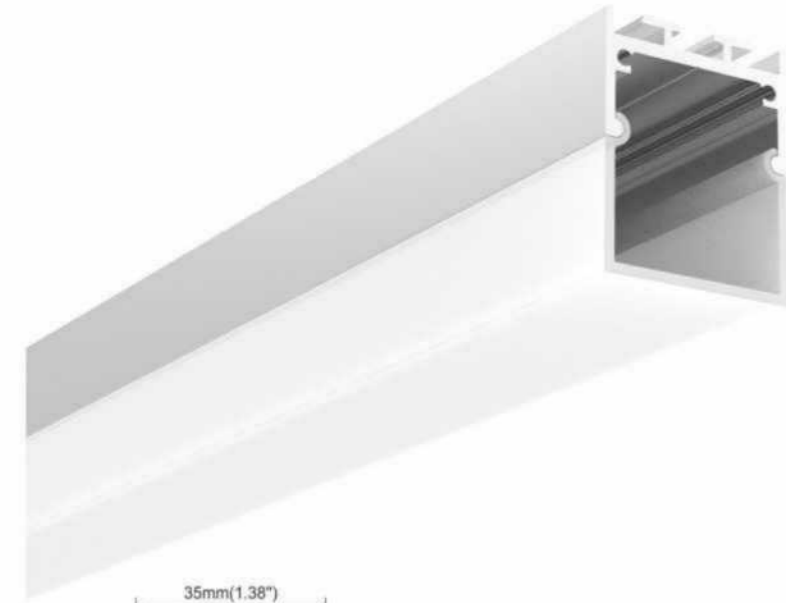

- PC diffused cover
- PC frosted cover



End cap without hole



Outside clip



Steel wire

ALP056

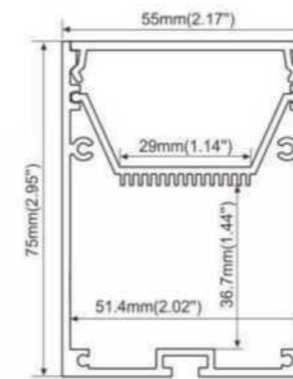
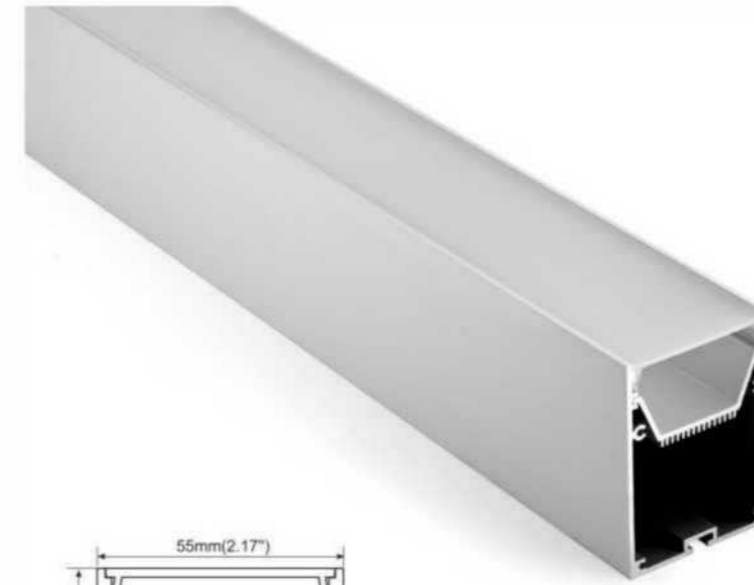

- PC frosted cover



End cap without hole



Steel wire

ALP054-R1

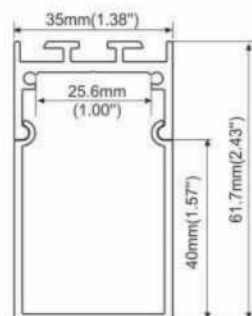
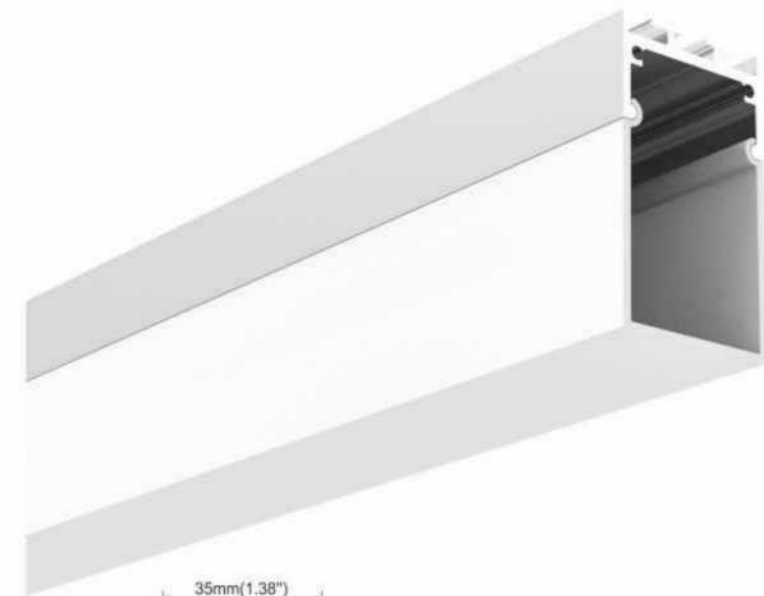

- PC diffused cover



End caps without hole



Outside clip



Steel wire

ALP056-D

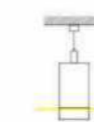
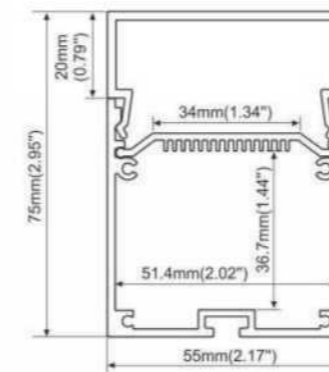
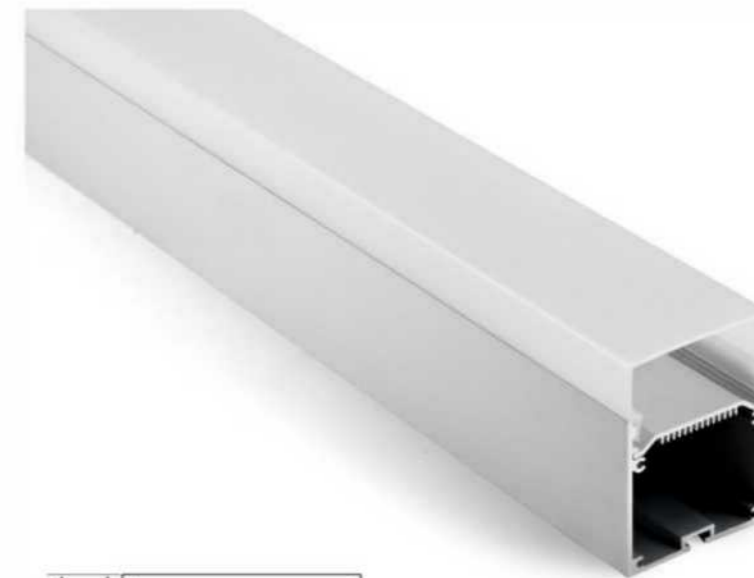

- PC frosted cover

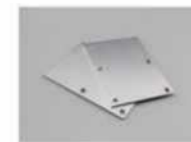

End cap without hole



Steel wire

ALP052

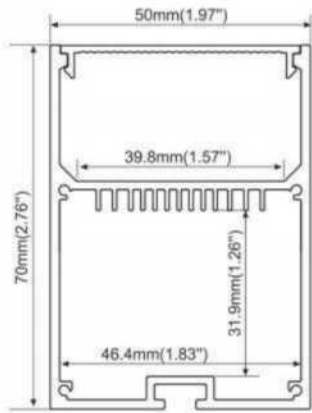
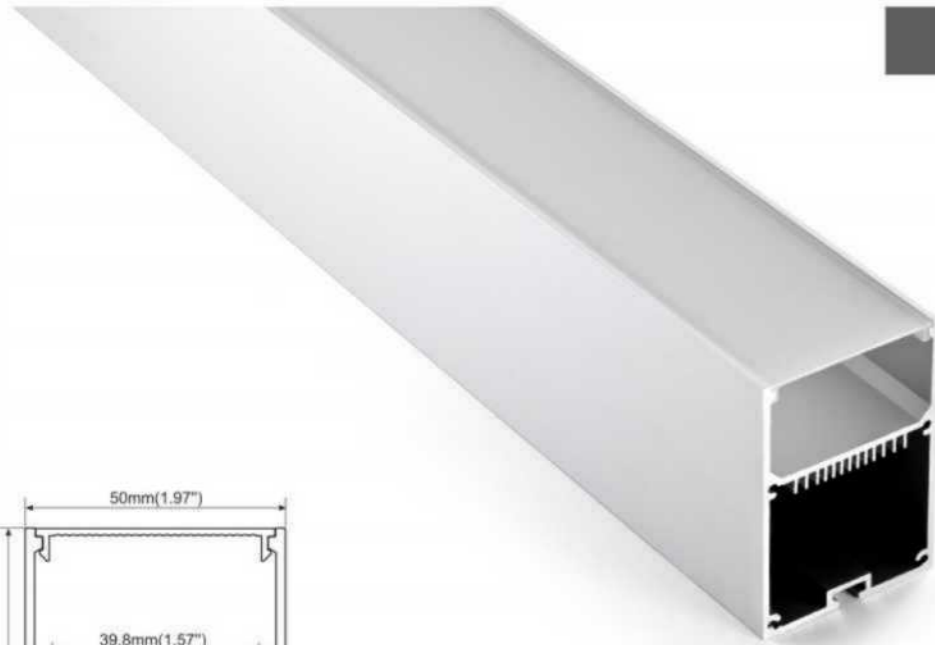

- PC diffused cover
- PC semi-clear cover



End cap without hole



90° Connector



180° Connector



Steel wire



ALP057

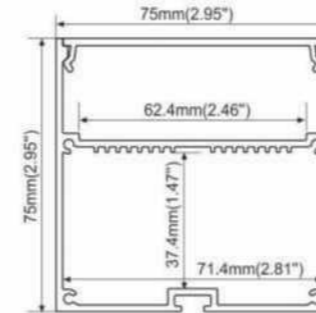

- PC diffused cover



End cap without hole



Steel wire



General Lighting Series

ALP3875

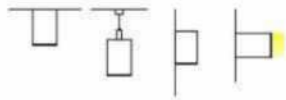
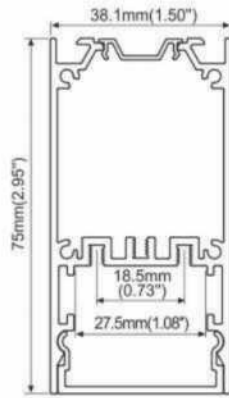
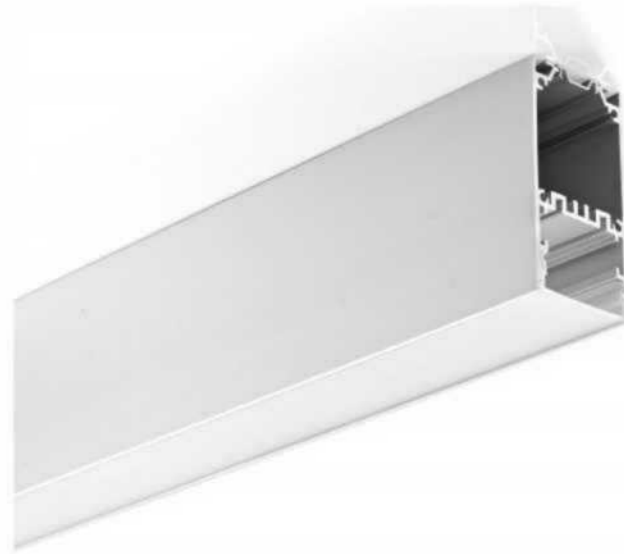

LED Module:2835LED
28W/1.2M

• PC frosted cover

Aluminium end cap without hole		Connector T
Stainless clip		Connector L
Steel wire		Connector X
LED Module:2835LED 28W/1.2M		Connector IL

General Lighting Series

ALP5075-R

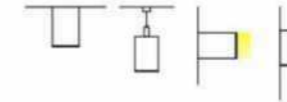
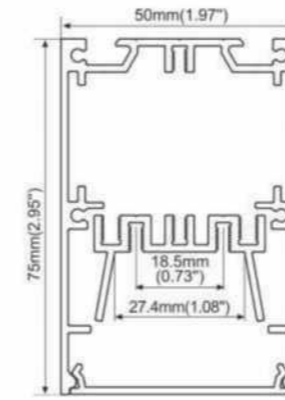
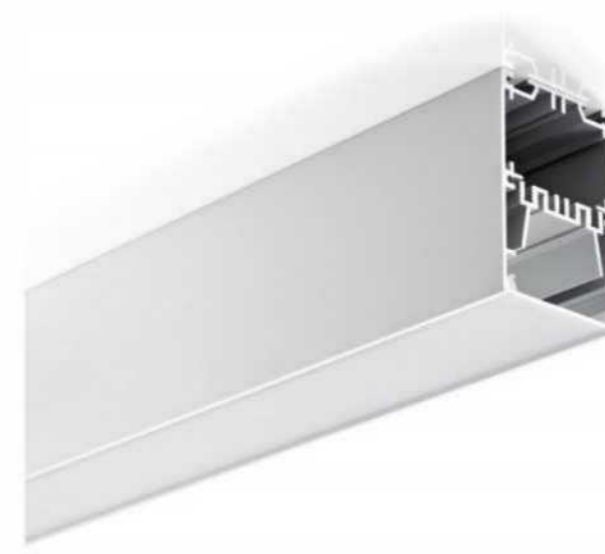

LED Module:2835LED
28W/1.2M

• PC frosted cover

Aluminium end cap without hole		Trimless recessed clip
Stainless clip		Connector T
Internal clip		Connector L
Steel wire		Connector X
LED Module:2835LED 28W/1.2M		Connector IL

ALP3875-D

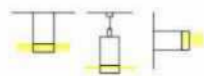
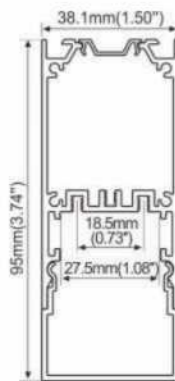

• PC frosted cover

	Aluminium end cap without hole
	Stainless Clip
	Steel wire
	LED Module:2835LED 28W/1.2M

ALP5075-RD

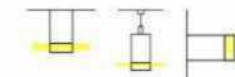
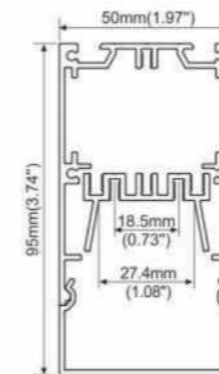
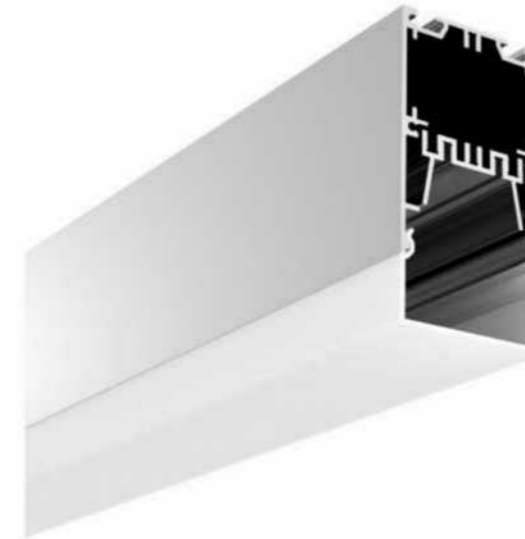







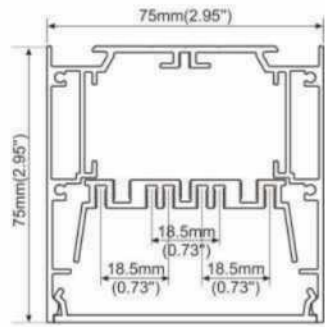



• PC frosted cover

	LED Module:2835LED 28W/1.2M
	Aluminium end cap without hole
	Stainless Clip
	Internal Clip
	Steel wire

ALP7575-R



- Aluminium end cap without hole   Steel wire
 - Stainless clip   Connector T
 - Internal clip   Connector L
 - Trimless recessed clip   Connector X
 - LED Module: 2835LED 42W/1.2M   Connector IL
- PC frosted cover

ALP7575-R

Installation methods

Pendent

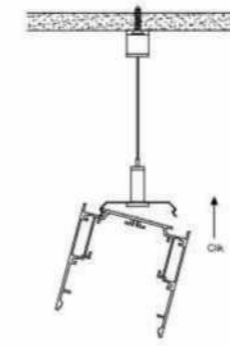

Step 01A

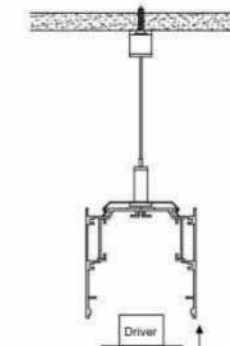

Step 02A

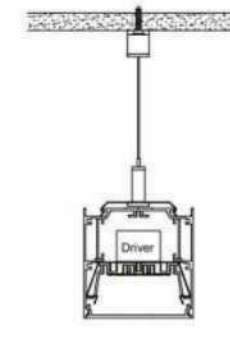

Step 03A

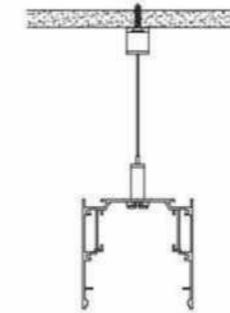

Step 01B

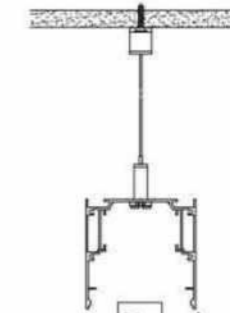

Step 02B

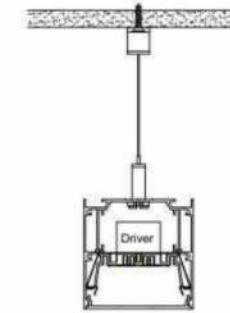

Step 03B

Surface

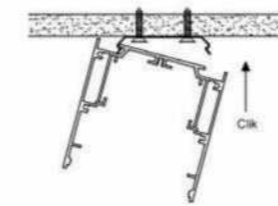

Step 01A

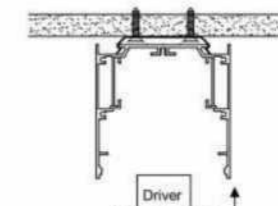

Step 02A

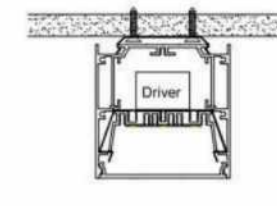

Step 03A

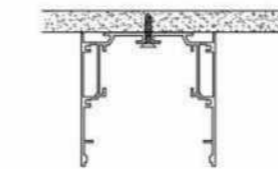

Step 01B

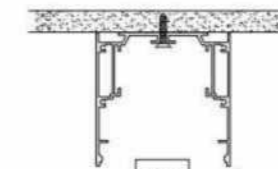



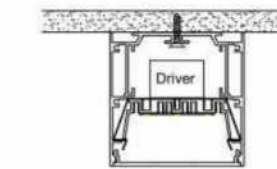

Step 02B

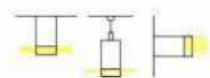
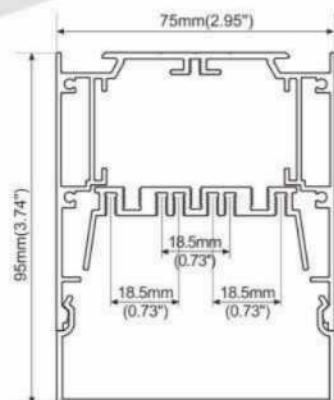
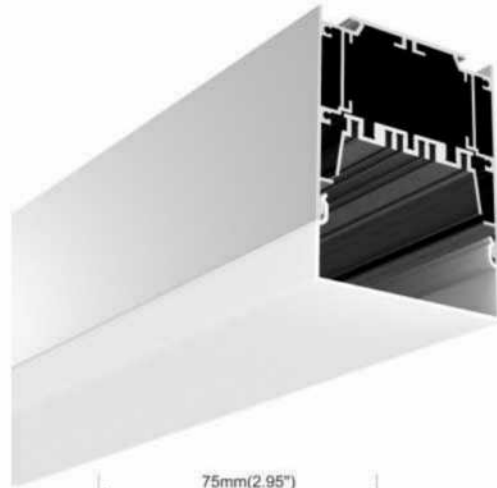

ALP7575-RD



- Aluminium end cap 
 - Stainless Clip 
 - Internal Clip 
 - Steel wire 
 - LED Module: 2835LED 42W/1.2M 
- PC frosted cover

ALP6875

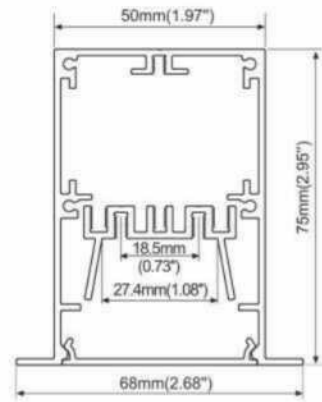

LED Module:2835LED
28W/1.2M

• PC frosted cover

Aluminium End Cap
without hole



Connector T



Stainless Clip



Connector L



Internal Clip



Connector X



Connector IL

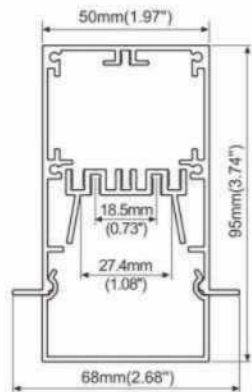

• PC frosted cover

ALP6875-D



Aluminium end cap



Stainless Clip



Internal Clip



LED Module:2835LED
28W/1.2M

ALP6875

Installation methods



Step 01:
Install the end caps

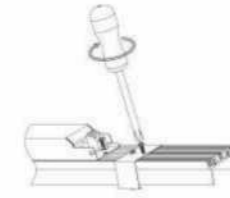

Step 06:
Install external clip and the driver



Step 02:
Install the recessed frame

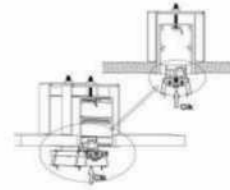

Step 07:
Push the gear tray inside the profile



Step 03:
Put the whole profile inside
the ceiling slot

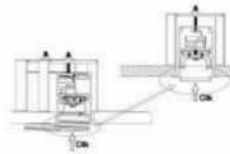

Step 08:
Press the diffuser inside

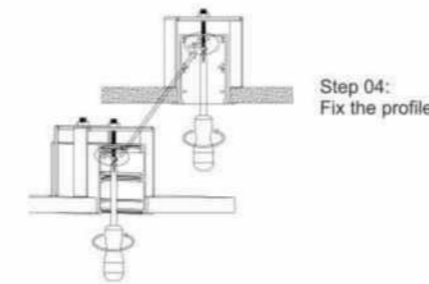

Step 04:
Fix the profile

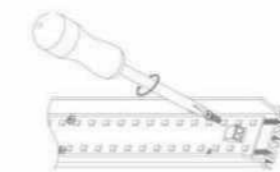

Step 05:
Fix the rigid led module



Step 09:
Installation completed

ALP9575-R

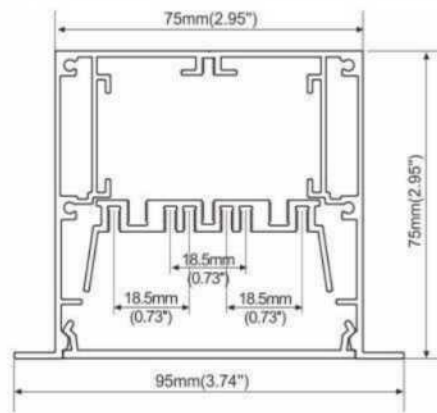
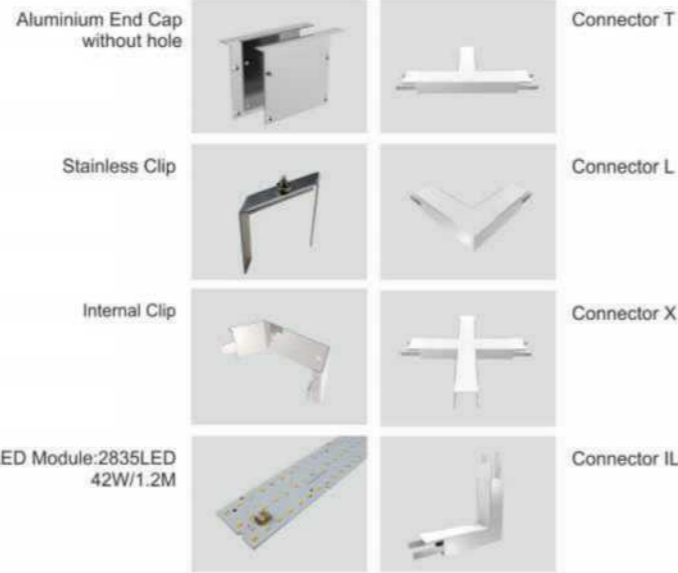

• PC frosted cover

ALP9575-RD

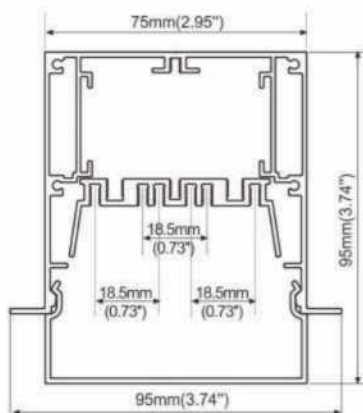
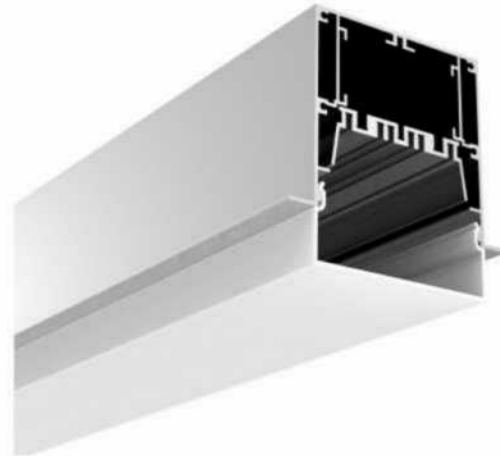

• PC frosted cover

ALP10075-R

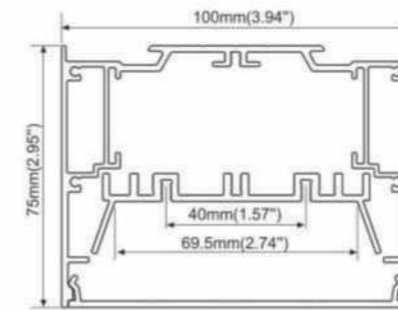

• PC frosted cover



ALP12575

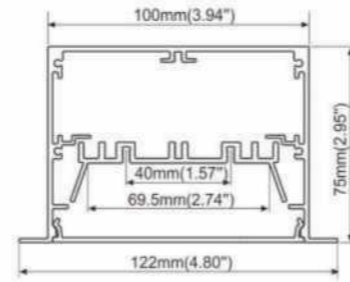
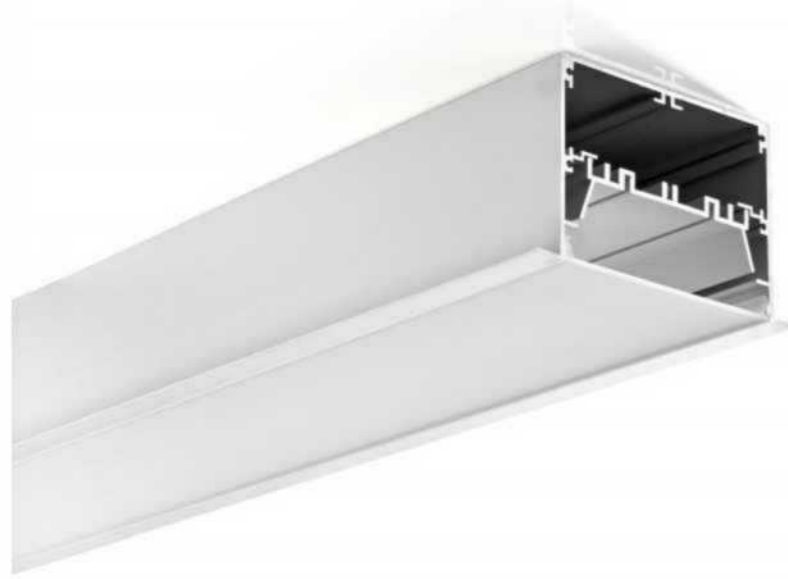

• PC frosted cover



Aluminium End Cap without hole



Connector T



Connector X



Stainless Clip



Connector L



Connector IL



Internal Clip



ALP5090

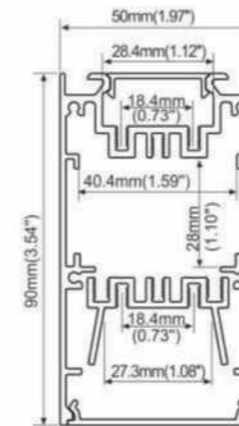

• PC frosted cover



End caps



Internal clip



Outside clip



Steel wire



LED Module: 2835LED 28W/1.2M

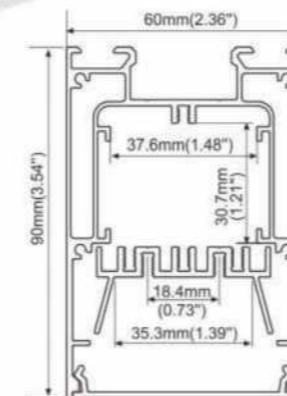

• PC frosted cover

ALP6090



End caps



Internal clip



Outside clip



Steel wire



LED Module: 2835LED 28W/1.2M

ALP5090

Installation methods

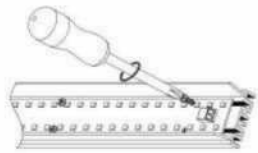

Step 01:
Fix the rigid led module

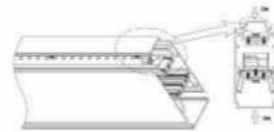

Step 05:
Press the diffuser inside

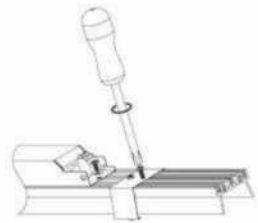

Step 02:
Fix the internal clip and driver



Step 06:
Install the end caps

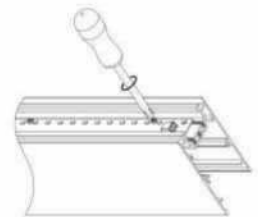

Step 03:
Fix the rigid led module (upwards)

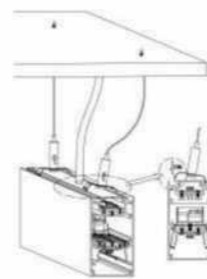

Step 07:
Fix external clip

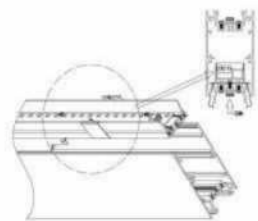

Step 04:
Install the safety wire and push the gear tray inside

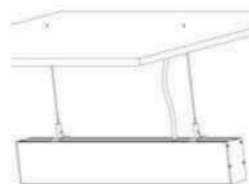

Step 08:
installation completed

ALP7595-UP

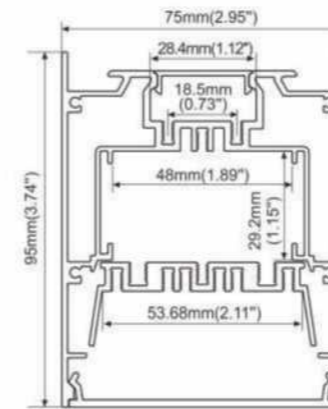

• PC frosted cover

- Aluminium profile 
- PC frosted cover 
- PC frosted cover 
- Aluminium end cap 
- Internal clip 
- Stainless clip 
- Steel wire 
- LED Module: 2835LED 42W/1.2M 
- LED Module: 2835LED 28W/1.2M 

ALP60108

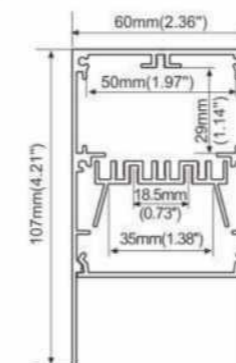

• PC frosted cover

- End caps 
- Internal clip 
- Outside clip 
- Steel wire 
- LED Module: 2835LED 28W/1.2M 

ALP049-R

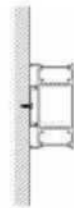
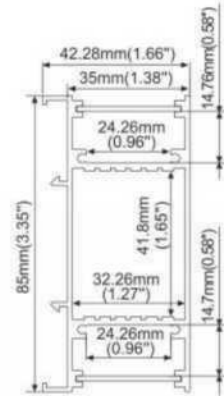
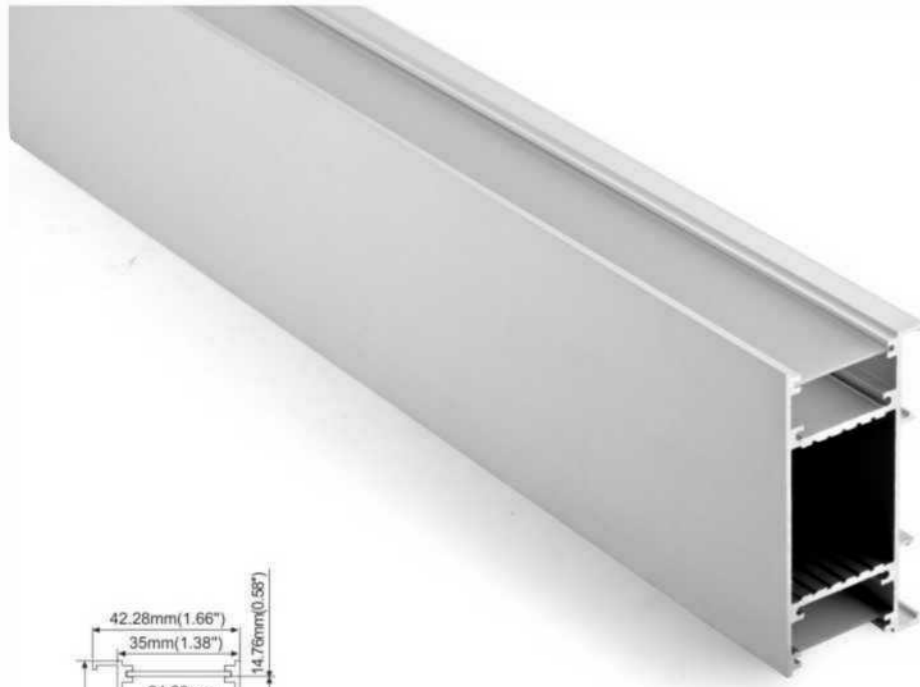

- PC diffused cover
- PC semi-clear cover



End cap without hole



Mounting clip(metal)

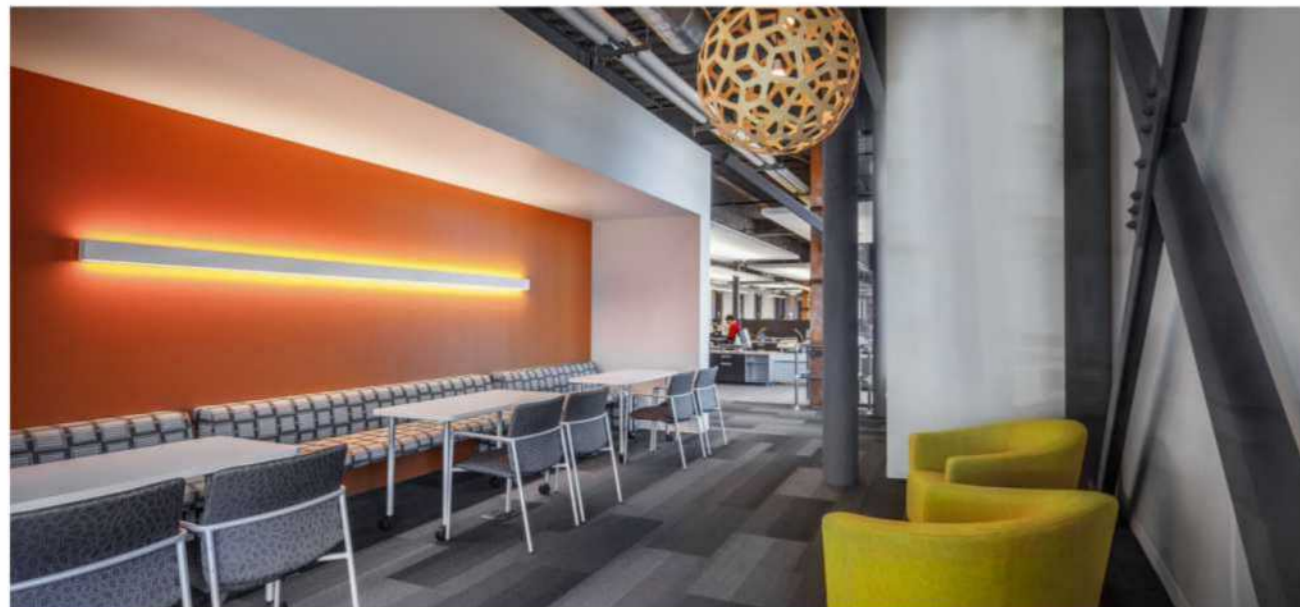

ALP12083

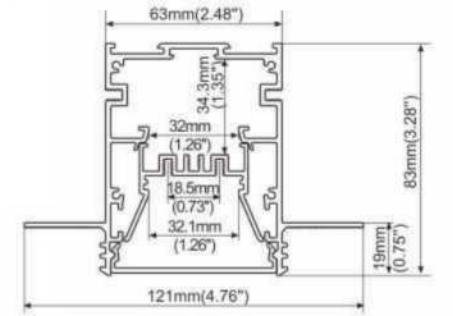

• PC frosted cover



End caps



Inside clip



Steel wire



Safety wire



Step 01:
Fix led rigid module



Step 04:
Press the diffuser inside



Step 07:
Fix the whole profile
on the ceiling



Step 02:
Fix the internal clips
and the driver



Step 05:
Install the end caps



Step 08:
Install the plasterboard



Step 03:
Fix the gear tray and
the safety wire

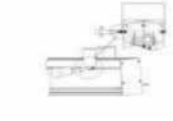

Step 06:
Install the recessed frame

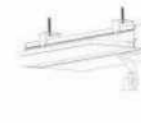

Step 09:
Paint the plaster



Step 10:
Paint lacquer (overcoating)

ALP065

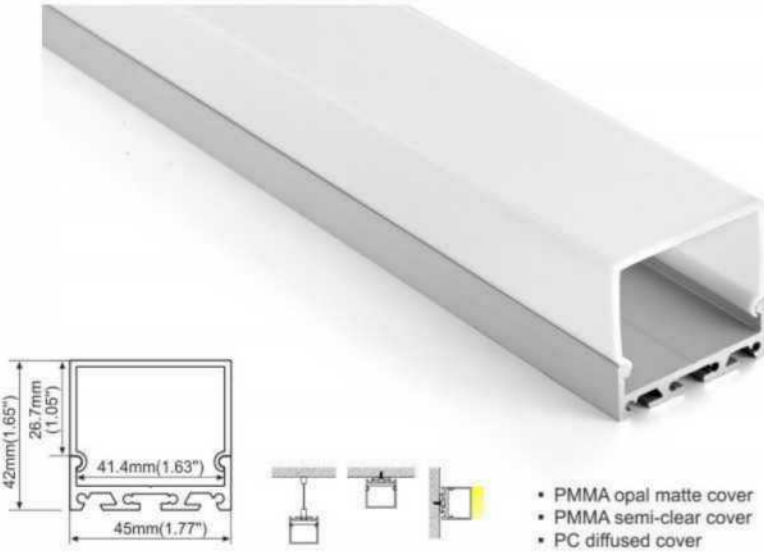

- PMMA opal matte cover
- PMMA semi-clear cover
- PC diffused cover



ALP065-T



- PC diffused cover



ALP066



- PMMA opal matte cover
- PMMA semi-clear cover
- PC diffused cover



T40



- PC frosted cover



T60



- PC frosted cover



T100



- PC frosted cover



T100

Installation methods

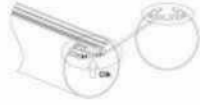

Step 01:
Install the diffuser



Step 03:
Fasten the base of
the steel wire

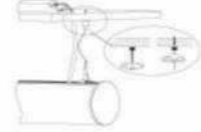

Step 05:
Fix the steel wire

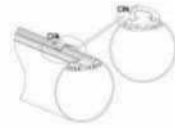

Step 02:
Fix the external clip



Step 04:
Install the end caps

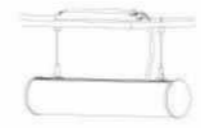

Step 06:
Installation completed



ALP6545-C

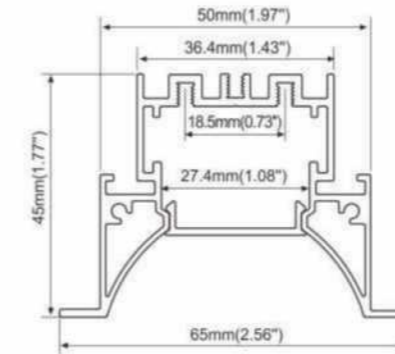

• PC frosted cover



End cap without hole



Stainless clip



LED Module: 2835LED
28W/1.2M

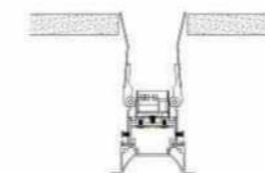

Step 01



Step 02

ALP5075-C

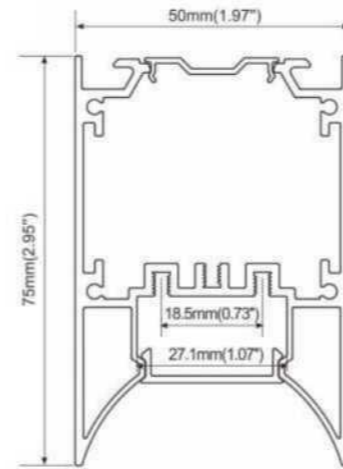

• PC frosted cover



Aluminium end cap without hole



Steel wire



Stainless clip



ALP8585

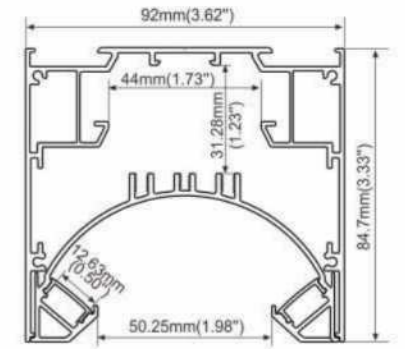
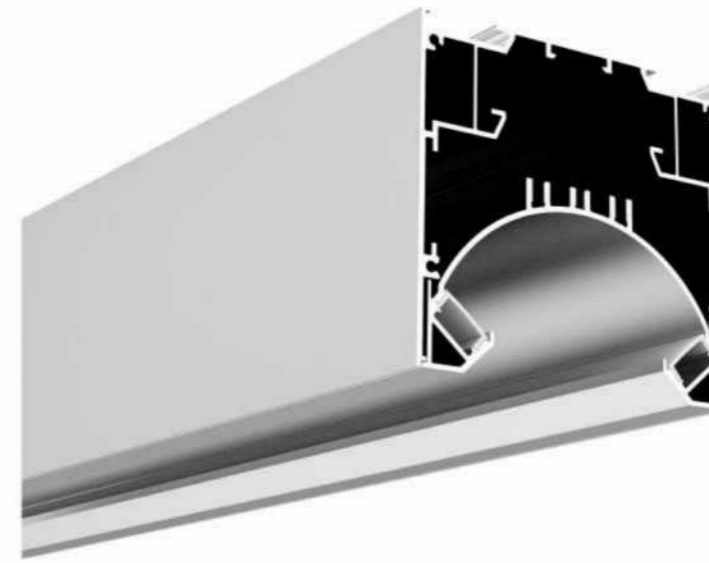

• PMMA semi-clear cover



Outside clip



Aluminium end cap



Safety wire



Internal clip



Steel wire



Step 01A:
Fix the internal clips
and the driver



Step 03A:
Install the end caps

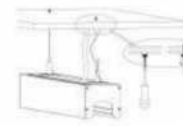

Step 05A:
Fix the steel wire



Step 02A:
Fix the gear tray
and the safety wire



Step 04A:
Fix the external clip



Step 06A:
Installation completed



Step 01B:
Install the end caps



Step 03B:
Fix the internal clips
and the driver



Step 05B:
Installation completed



Step 02B:
Fix the whole
Aluminum profile



Step 04B:
Fix the gear tray and the
safty wire

ALP7575-RL

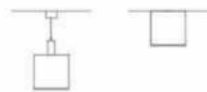
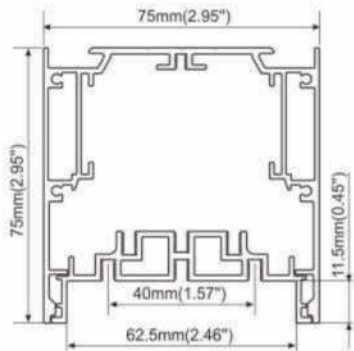

Lens: 30/60degrees, asymmetrical or symmetrical



End caps



Internal clip



Outside clip



LED Module: 2835LED 42W/1.2M



Steel wire

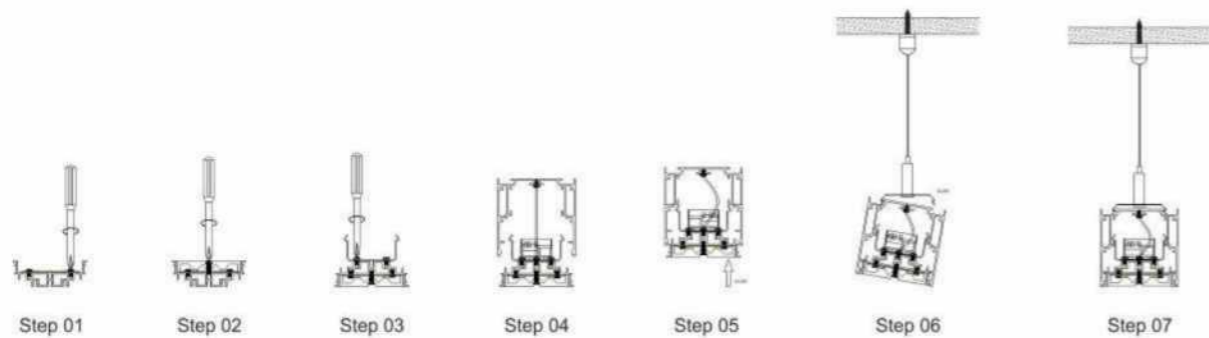

ALP100-WR

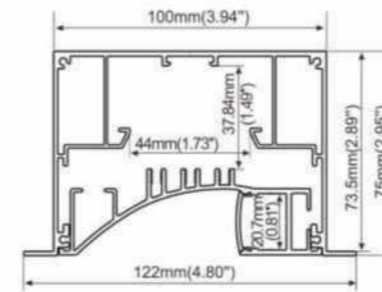
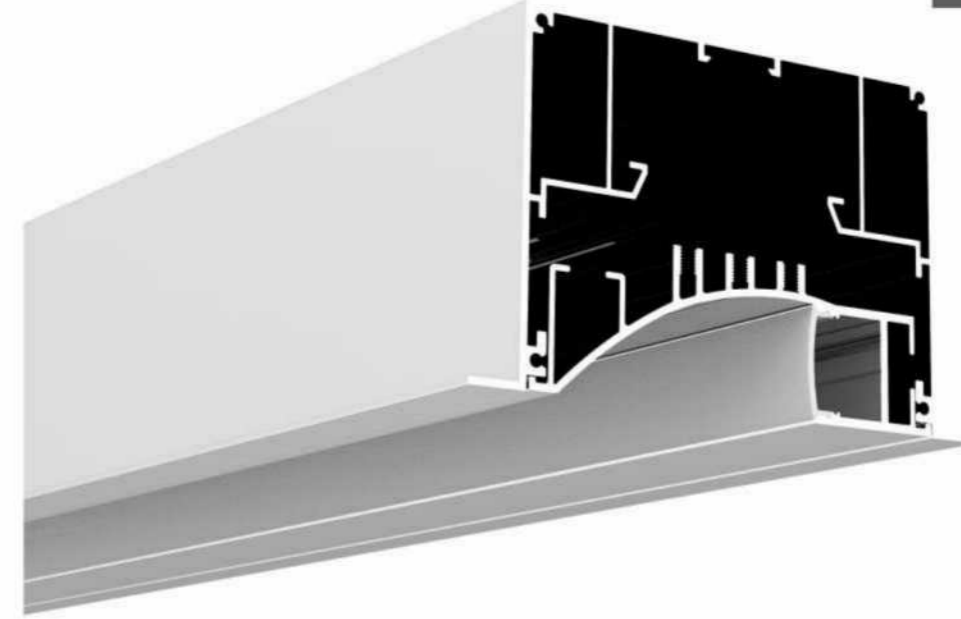

• PMMA semi-clear cover



End caps



Internal clip



safety wire



Stainless clip

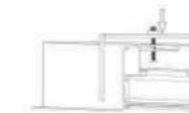

Step 01: Install the recessed frame



Step 02: Fix the end caps



Step 03: Push the whole profile inside the ceiling



Step 04: Rotate the screw and fix the profile



Step 05: Stick led strip

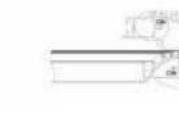

Step 06: Install diffuser



Step 07: Fix the internal clip

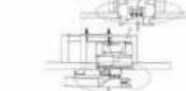

Step 08: Push the gear tray inside, with safety wire



Step 09: Installation completed

ALP15023

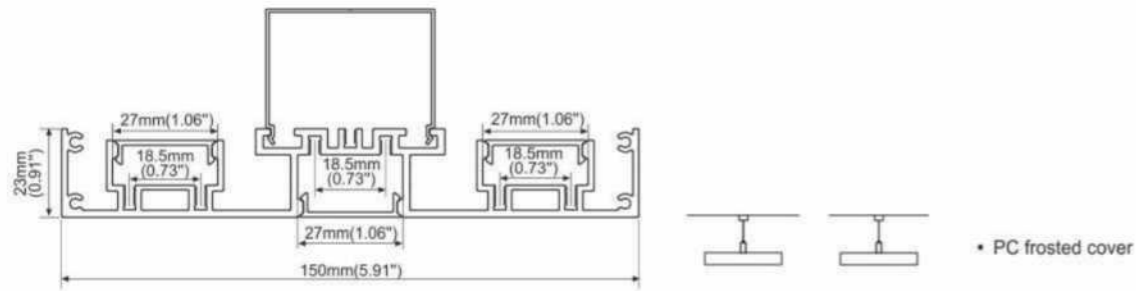
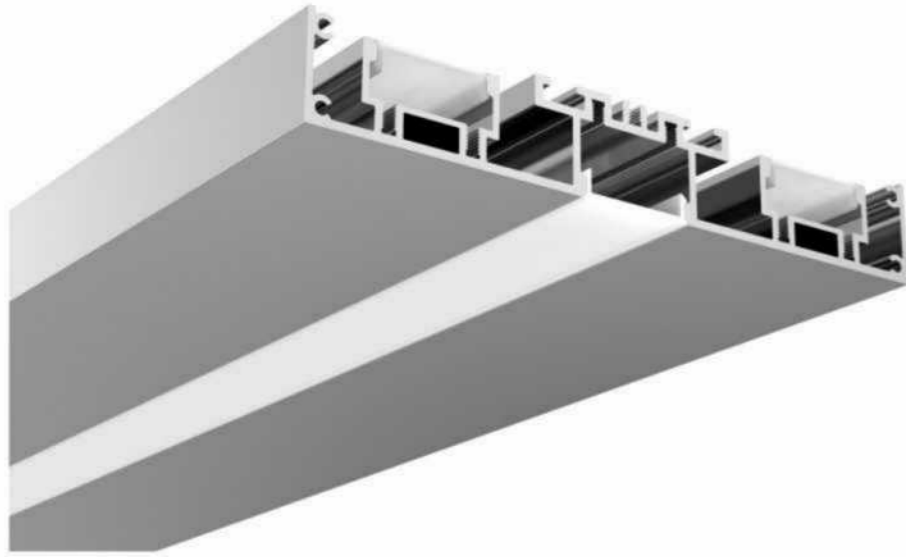

Aluminium end cap without hole



Aluminium cover for driver



Steel wire



ALP3875-R

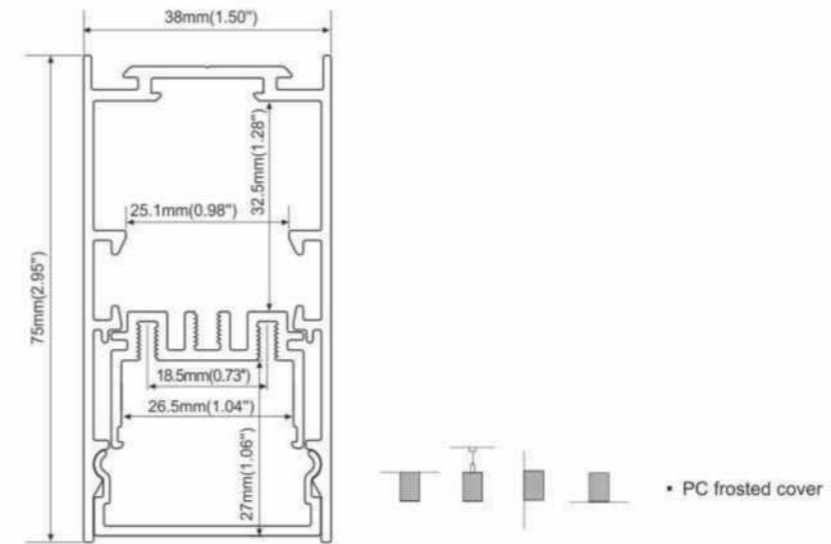

Die cast end caps



Inside clip



Outside clip



Steel wire



Safety wire

ALP38115

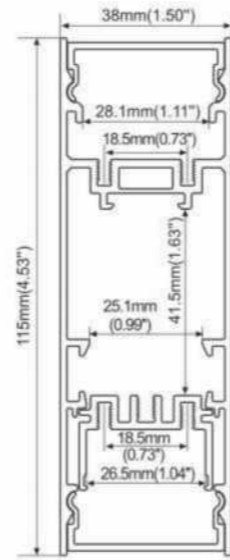





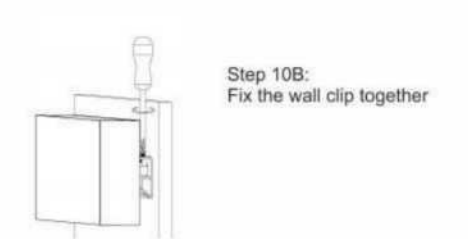
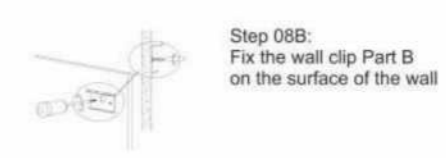
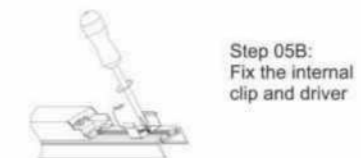
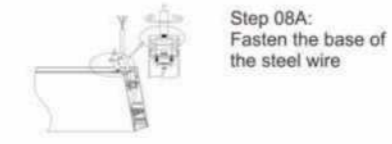
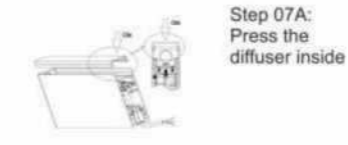
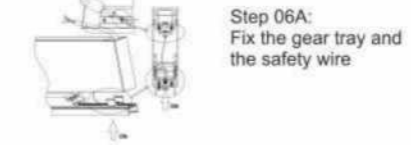





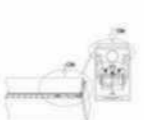

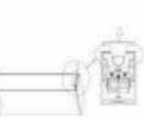





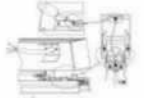





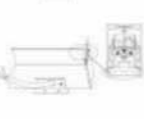

ALP38115

Installation methods

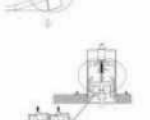

ALP5075-R1
Installation methods

	Step 01A: Install end caps		Step 04A: Install the safety wire and push the gear tray inside		Step 07A: Install external clip
	Step 02A: Fix the rigid led module		Step 05A: Press the diffuser inside		Step 08A: Install the steel wire
	Step 03A: Fix the internal clip and driver		Step 06A: Insert the cover plate		Step 09A: Installation completed
	Step 01B: Install end caps		Step 04B: Install external clip		Step 06B: Press the diffuser inside
	Step 02B: Fix the Aluminum profile		Step 05B: Install the safety wire and push the gear tray inside		Step 07B: Insert the cover plate
	Step 03B: Fix the rigid led module on heatsink board		Step 08B: Installation completed		
	Step 01C: Fix the wall clip Part A on the surface of the Aluminum profile		Step 05C: Install the safety wire and push the gear tray inside		Step 09C: Fix the whole fixture
	Step 02C: Install the end caps		Step 06C: Press the diffuser inside		Step 10C: Fix the wall clip together
	Step 03C: Fix the rigid led module		Step 07C: Insert the cover plate		Step 11C: Installation completed
	Step 04C: Fix the internal clip and driver				
	Step 01D: Install trimless recessed frame		Step 04D: Fix the rigid led module		Step 07D: Press the diffuser inside
	Step 02D: Push the profile inside the ceiling slot		Step 05D: Fix the internal clip and driver		Step 08D: Insert the cover plate
	Step 03D: Fix the profile by rotating the long screw		Step 06D: Install the safety wire and push the gear tray inside		Step 09D: Installation completed

ALP5075-R1

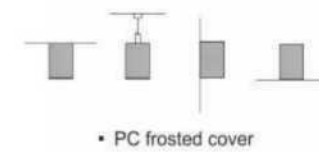
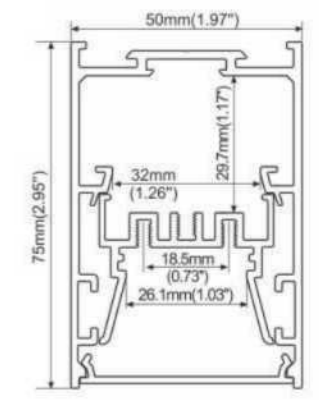
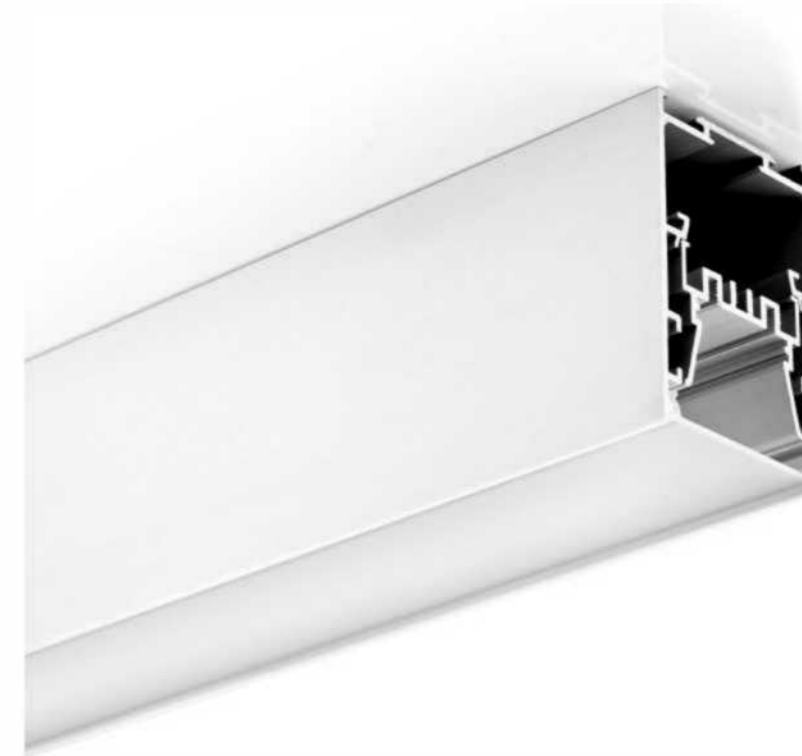

ALP50120

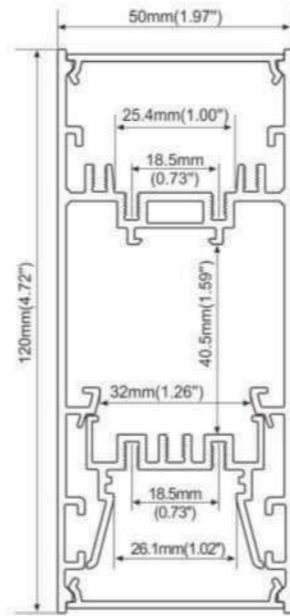

Pendent mounting

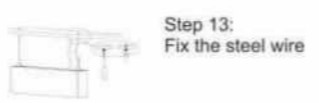
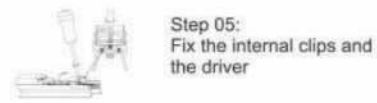
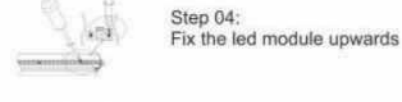
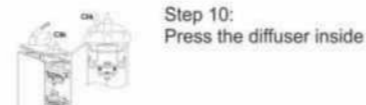
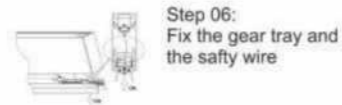
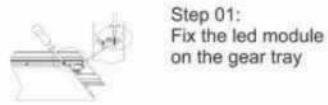

ALP50120

Installation methods

Wall mounting



Step 01:
Fix the wall clip Part A on the surface of the Aluminum profile



Step 02:
Install the end caps



Step 03:
Fix the rigid led module



Step 04:
Intall the safety wire and push the gear tray inside

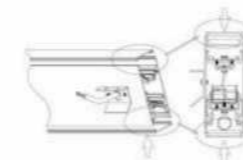

Step 05:
Press the diffuser inside

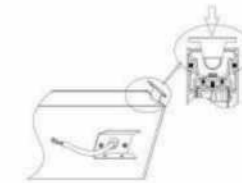

Step 06:
Insert the cover plate

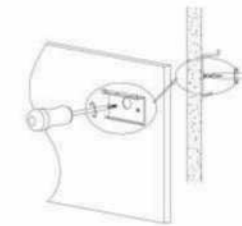

Step 07:
Fix the wall clip Part B on the surface of the wall

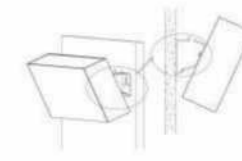

Step 08:
Adjust the whole fixture into suitable position

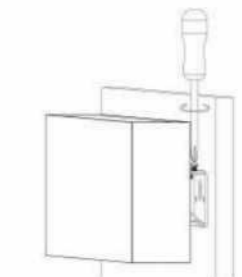

Step 09:
Fix the wall clip together

ALP6380

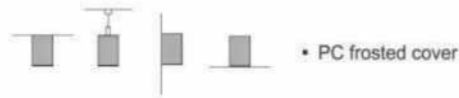
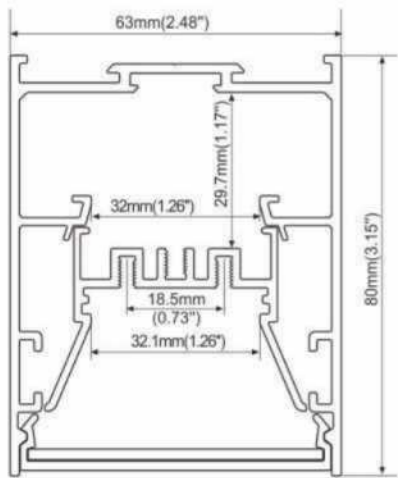
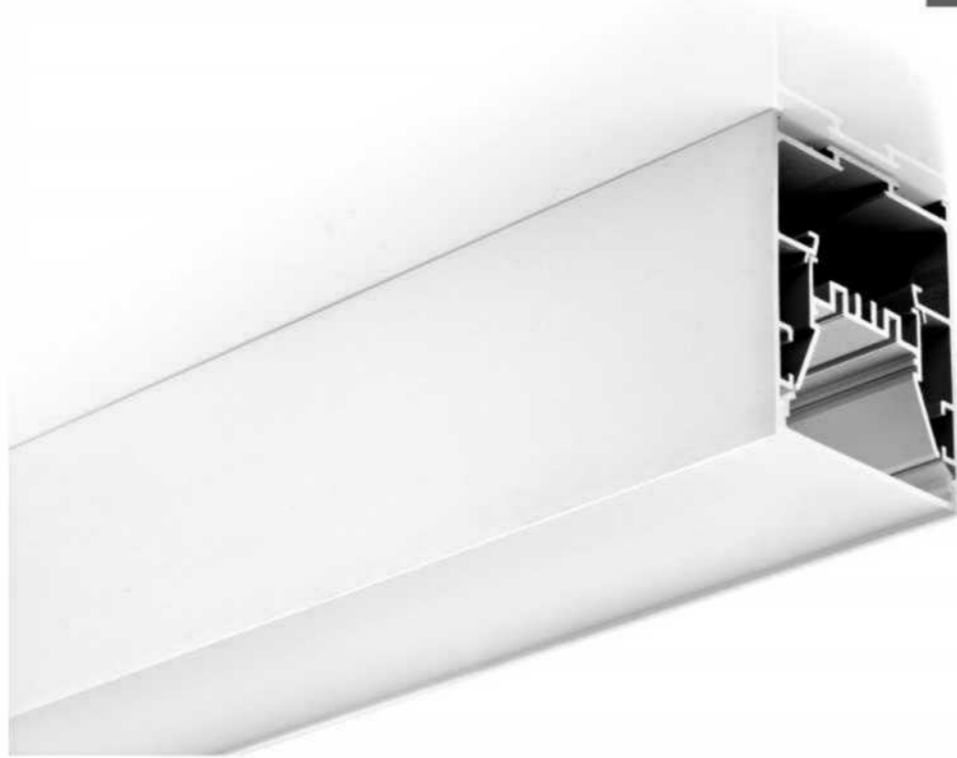

ALP63120

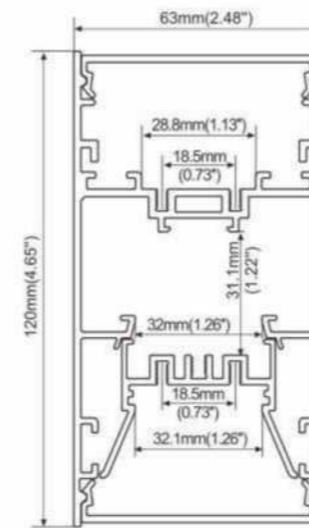



General Lighting Series



ALP7578

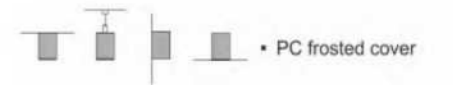
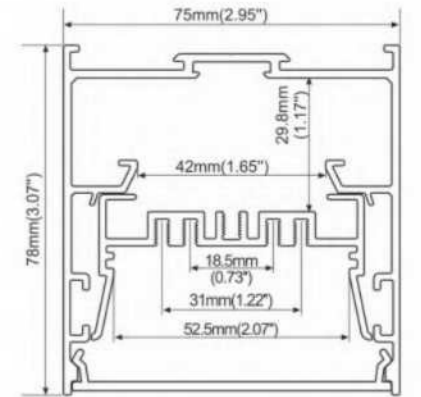
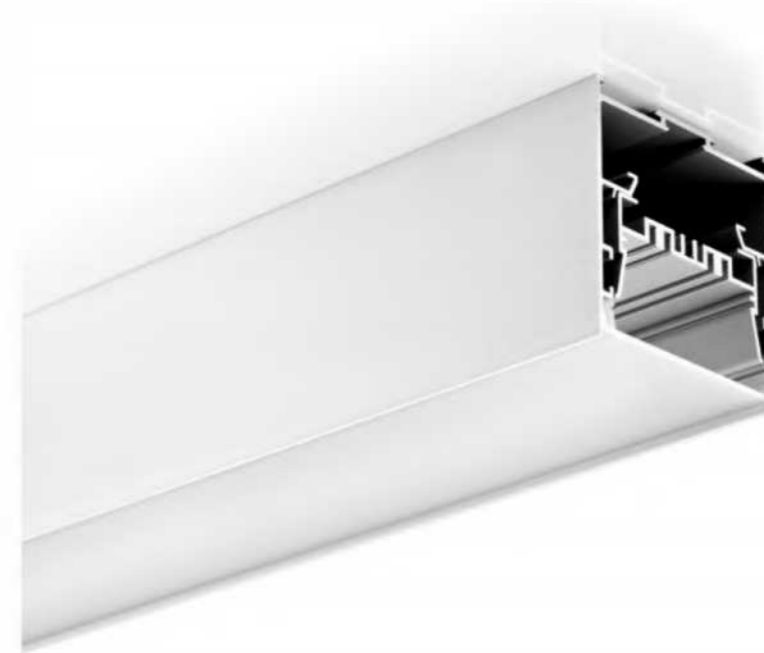

Die cast end caps



Inside clip



Outside clip



Steel wire



Safety wire



ALP7578

Installation methods

Surface mounting

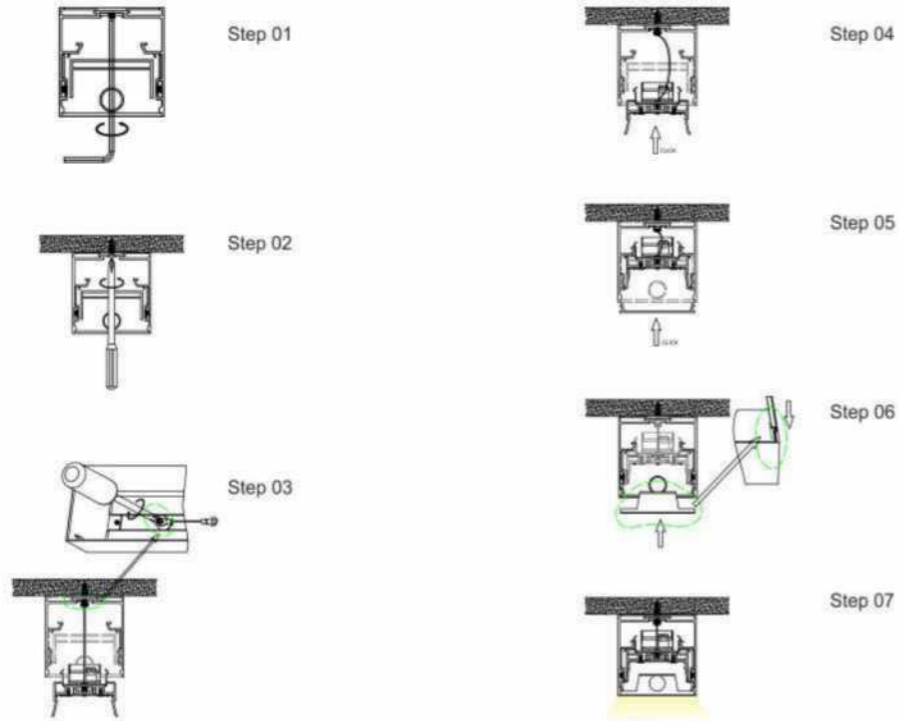

Pendent mounting

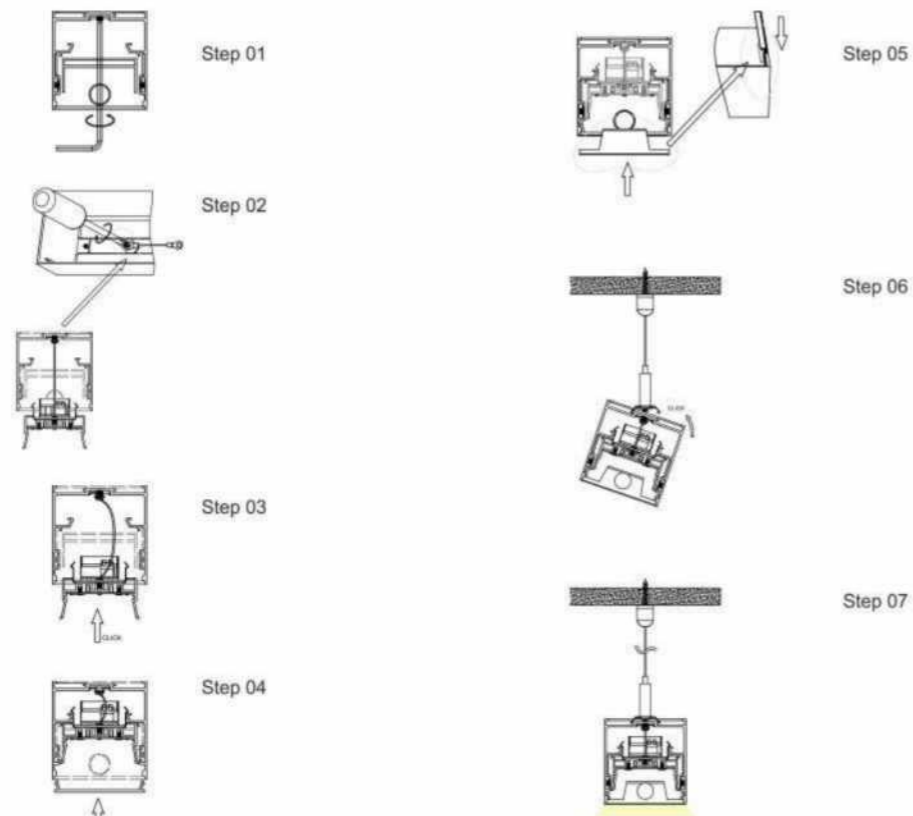

ALP75120

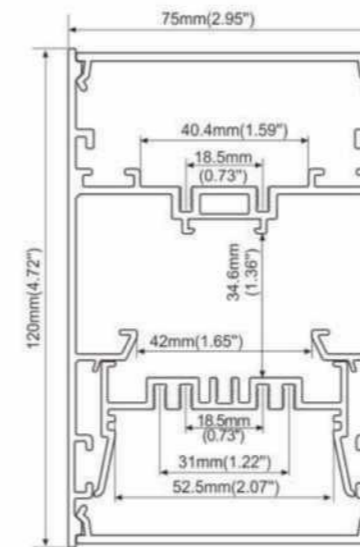

ALP10078

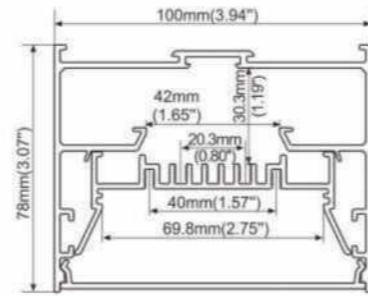
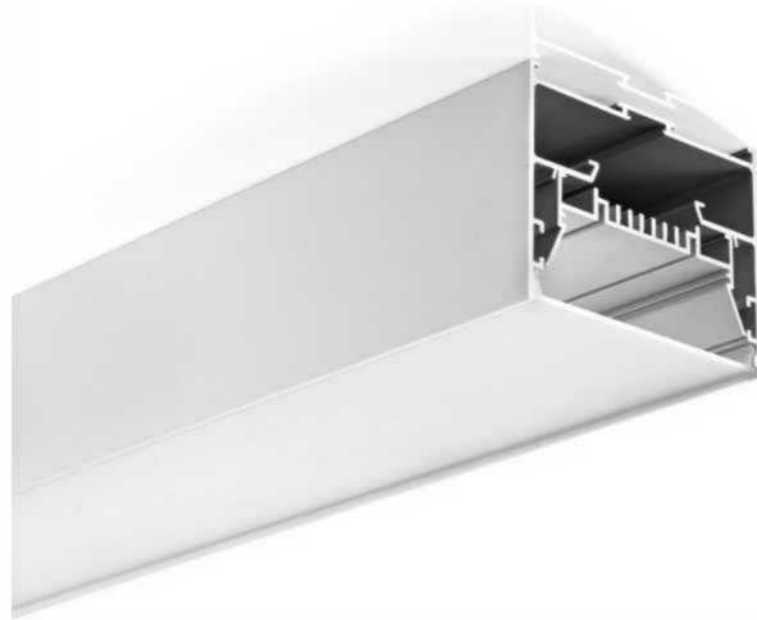

Die cast end caps



Inside clip



Outside clip



Steel wire



Safety wire

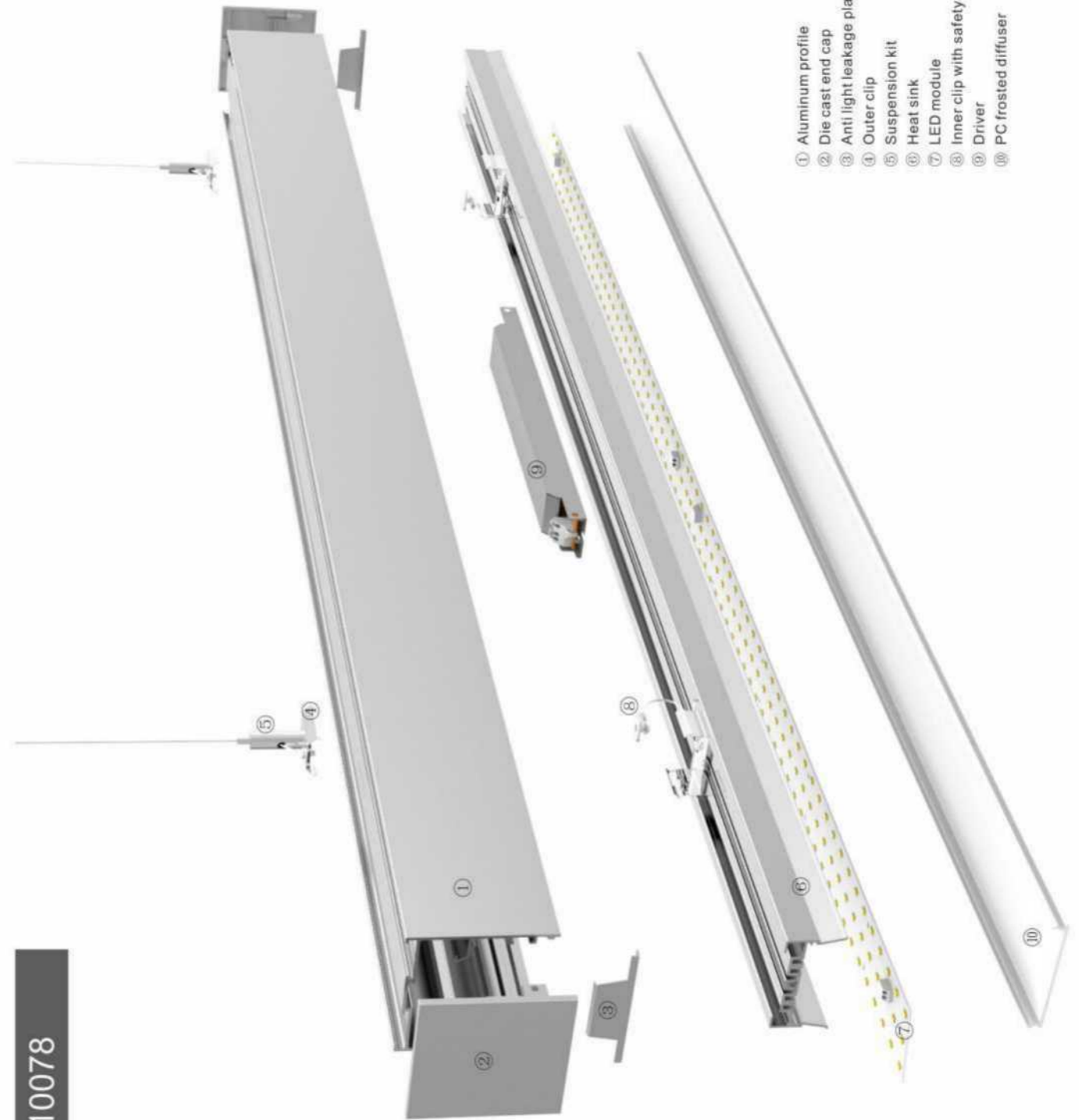

- ① Aluminum profile
- ② Die cast end cap
- ③ Anti light leakage plate
- ④ Outer clip
- ⑤ Suspension kit
- ⑥ Heat sink
- ⑦ LED module
- ⑧ Inner clip with safety rope
- ⑨ Driver
- ⑩ PC frosted diffuser

ALP10078

ALP100120

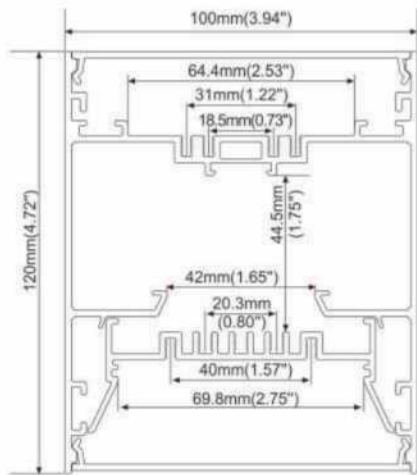

ALP023-R2

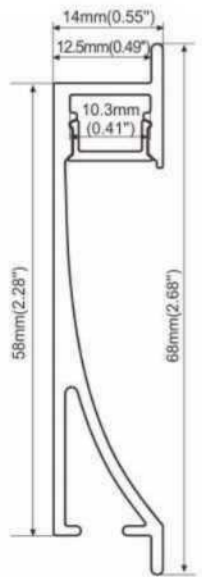

Aluminum profile



End caps



PC diffused cover

ALP024

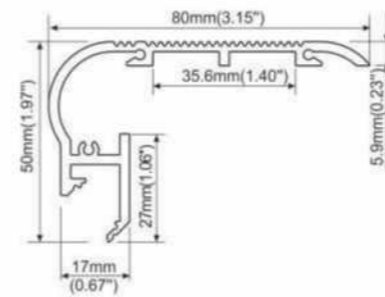

- PMMA opal matte cover
- PMMA semi-clear cover
- PC diffused cover



End cap with hole
End cap without hole

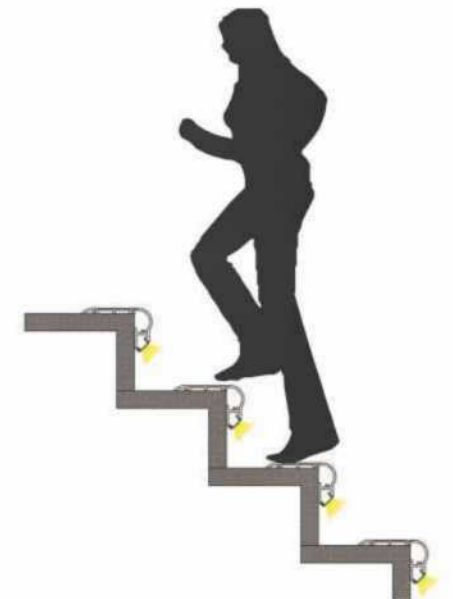
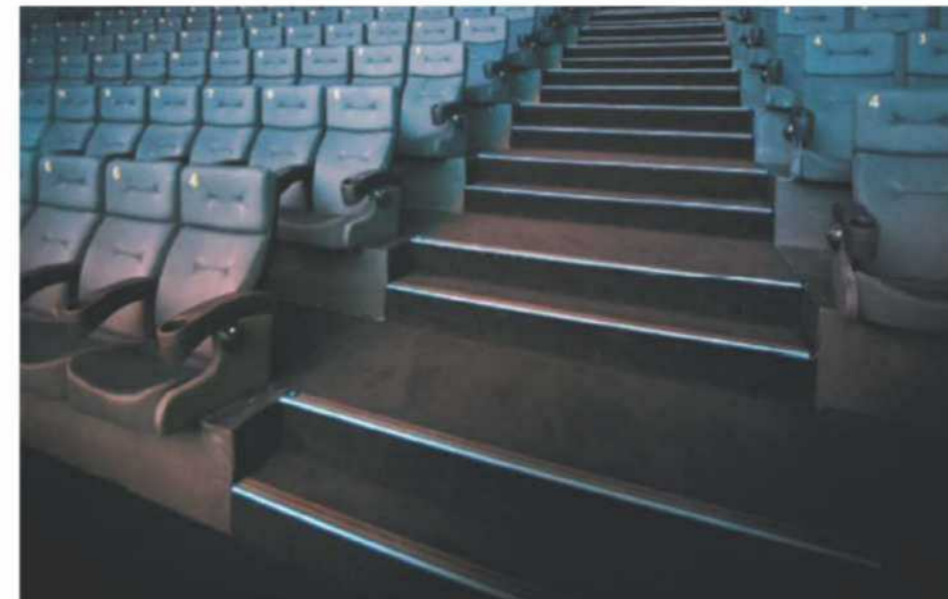

ALP024-R

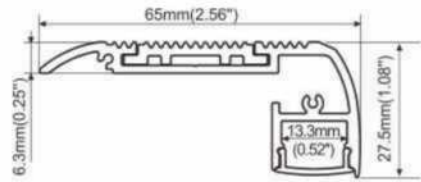

• PC diffused cover



End cap



PVC anti-skid cover

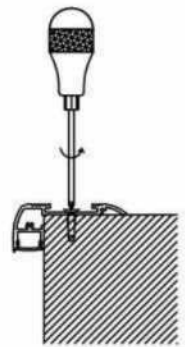

Step 01



Step 02



Step 03

ALP024-R1

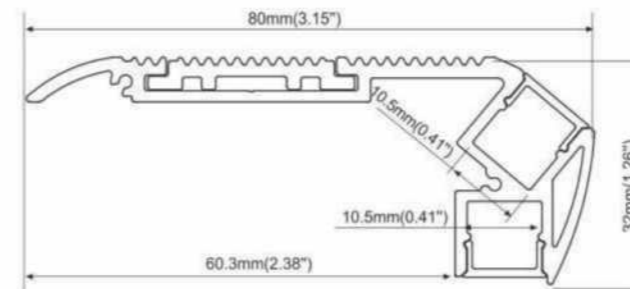

PC diffused cover



End cap with hole



End cap without hole



PVC anti-skid cover

SK1580-5



End caps

- PC diffused cover
- Lighting height adjustable, 5mm or 10mm or 18mm high

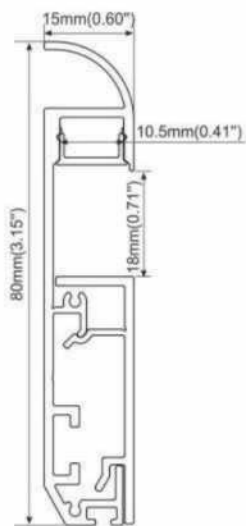
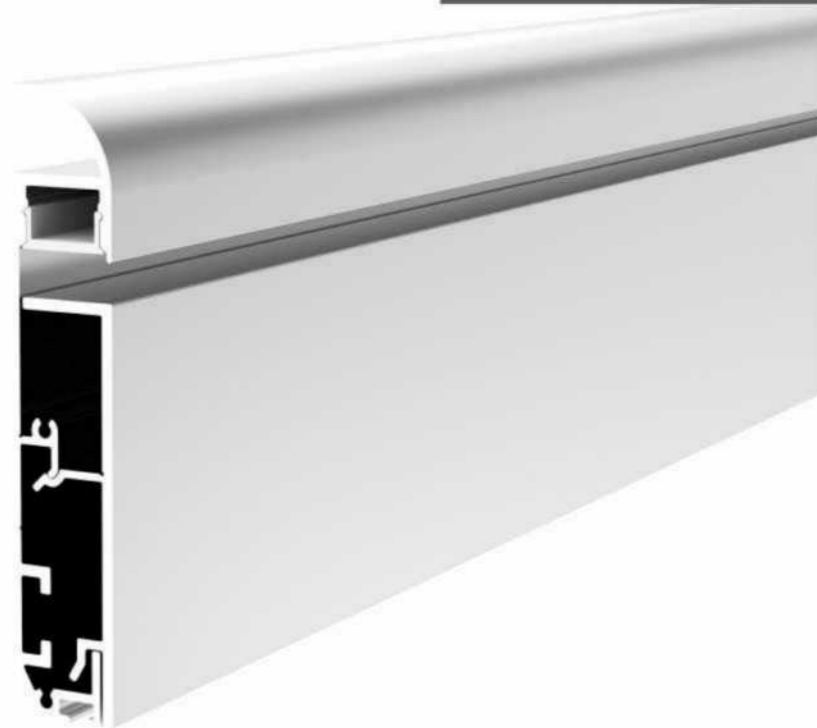

SK1580-18

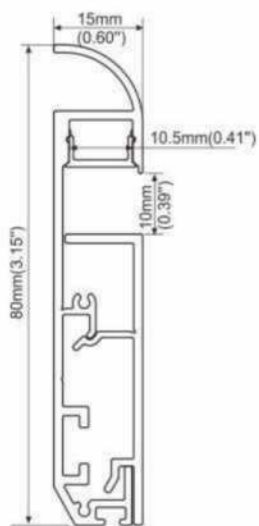

SK1580-10

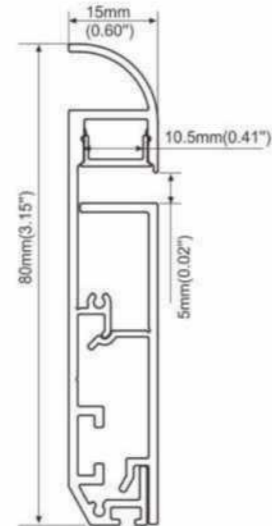

SK1580-5

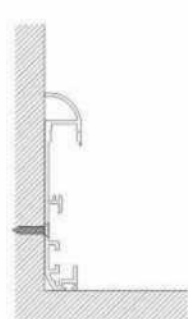
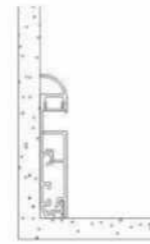

Step 01
Fix the base of aluminum first

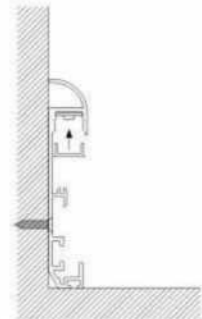

Step 02
Stick the the led strip and snap the cover

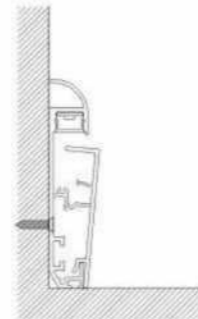

Step 03
Install the adjustable Aluminum cover

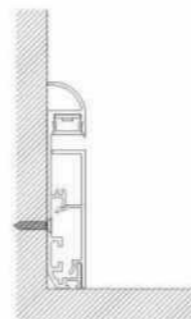

Step 04
Finished

SK1580TR-5



End caps

- PC diffused cover
- Lighting height adjustable, 5mm or 10mm or 18mm high

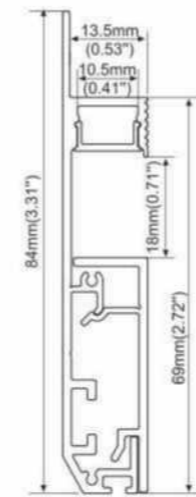

SK1580TR-18

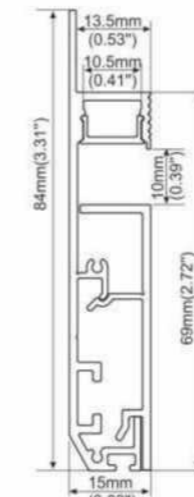

SK1580TR-10

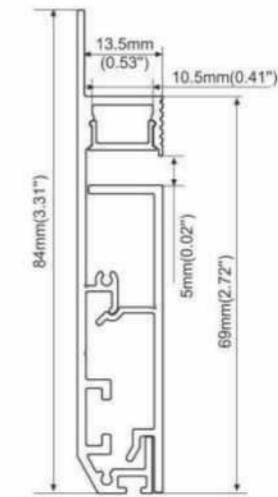

SK1580TR-5

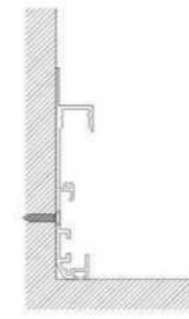
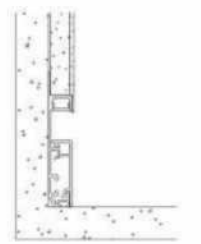

Step 01
Fix the Aluminum base first

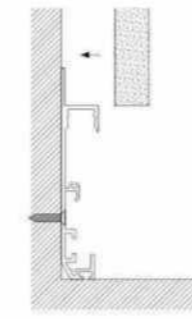

Step 02
Fix the drywall

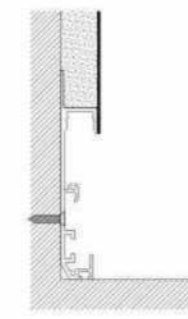

Step 03
Paint the drywall

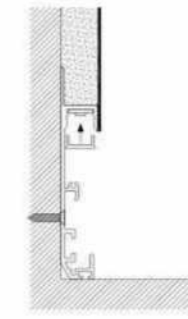

Step 04
Stick the the led strip and snap the cover

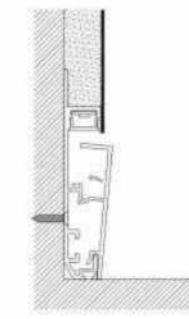

Step 05
Install the adjustable Aluminum cover

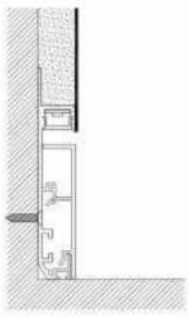

Step 06
Finished

ALP068-S

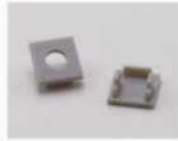
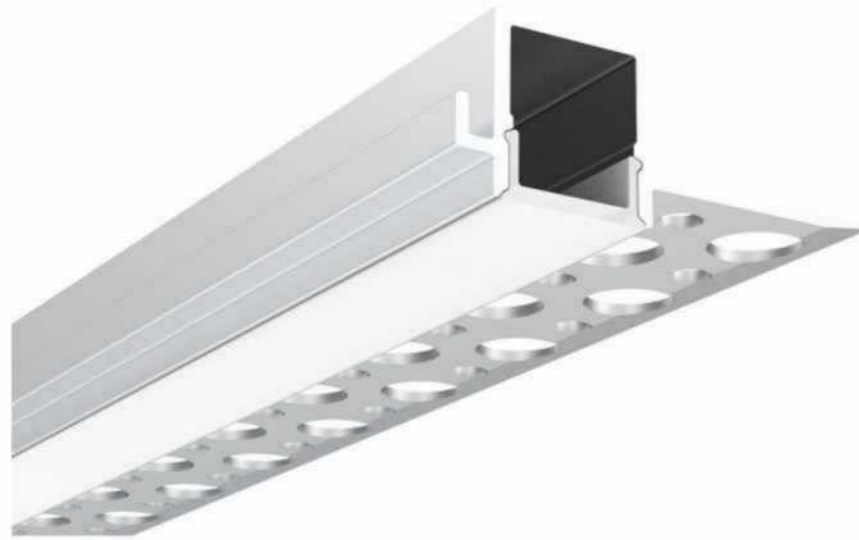

End caps



Black PC cover

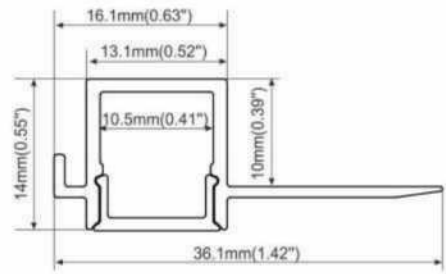

• PC diffused cover

ALP069-R

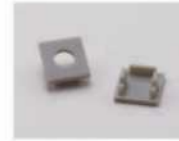
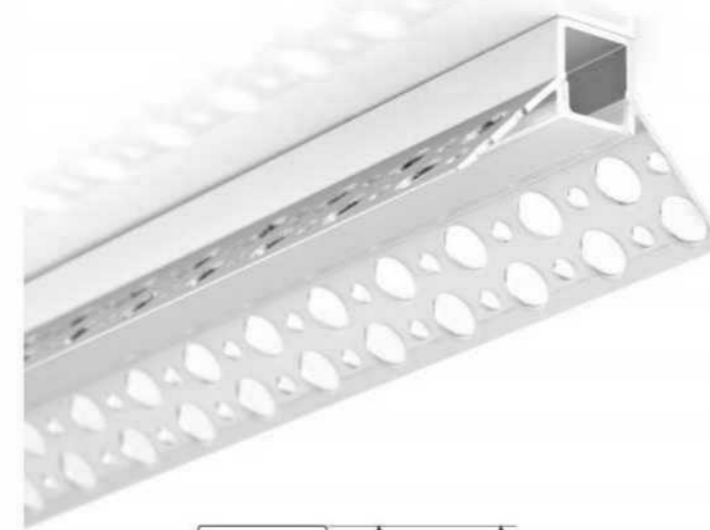

End caps



Black PC cover

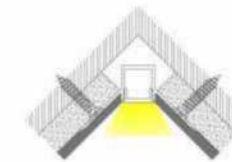
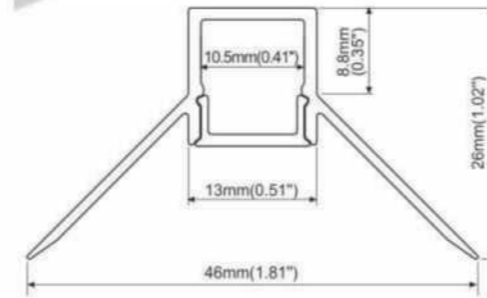

• PC diffused cover

ALP068-R

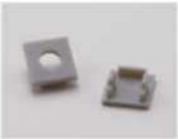
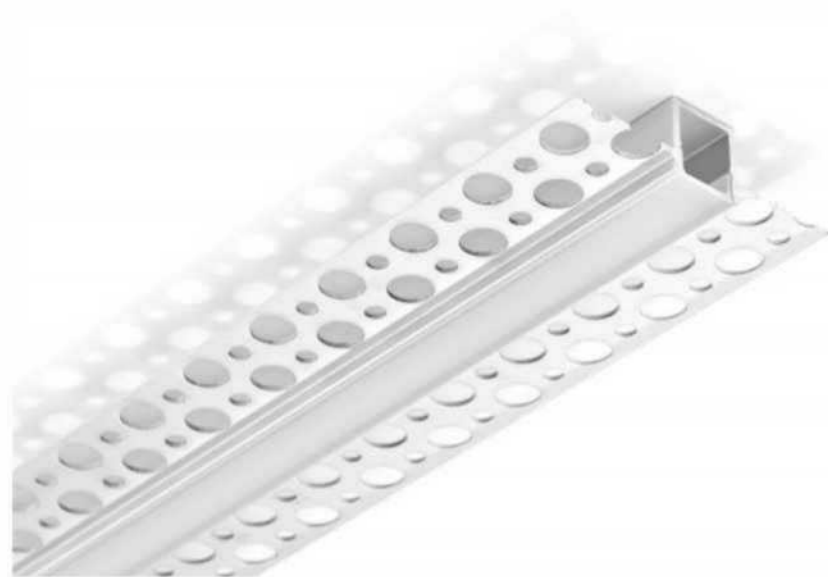

End caps

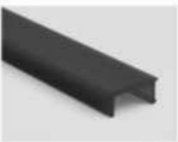

Black PC cover

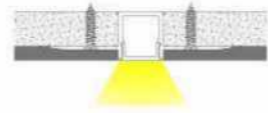
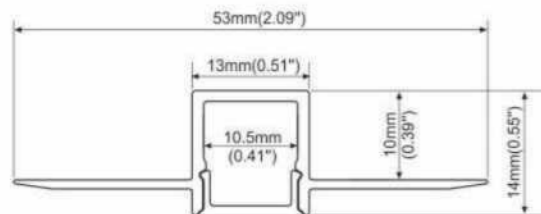

• PC diffused cover

ALP070-R

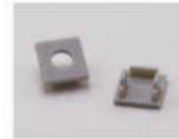

End caps



Black PC cover

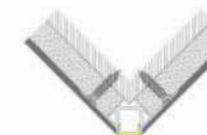
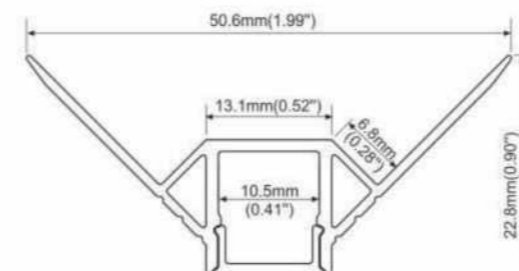

• PC diffused cover



ALP068-R

Installation methods



Step 01:
Fix the profile
on plasterboard



Step 02:
Painting the Plaster



Step 03:
Paint lacquer(overcoating)

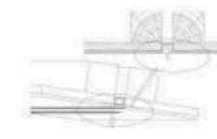

Step 04:
Stick led strip

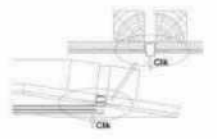

Step 05:
Install diffuser

ALP069-R

Installation methods



Step 01:
Fix the profile
on plasterboard



Step 02:
Painting the Plaster



Step 03:
Paint lacquer(overcoating)



Step 04:
Stick led strip



Step 05:
Install diffuser

ALP070-R

Installation methods



Step 01:
Fix the profile
on plasterboard



Step 02:
Painting the Plaster



Step 03:
Paint lacquer(overcoating)



Step 04:
Stick led strip



Step 05:
Install diffuser

ALP071

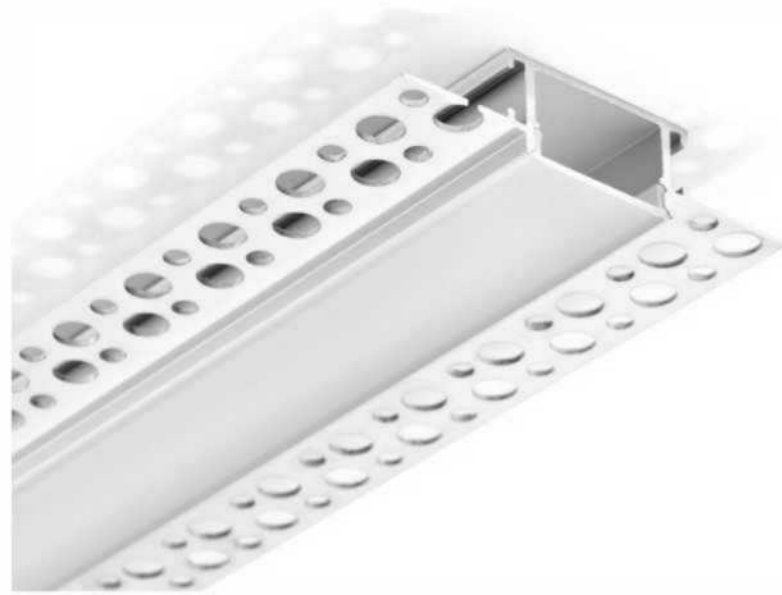

End caps



Black PC cover

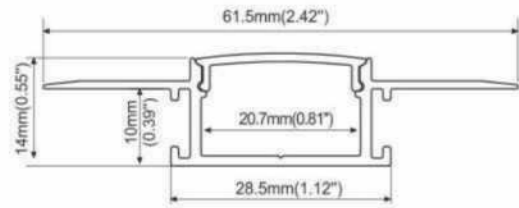

- PMMA opal matte cover
- PMMA semi-clear cover
- PMMA clear cover
- PC diffused cover

ALP080

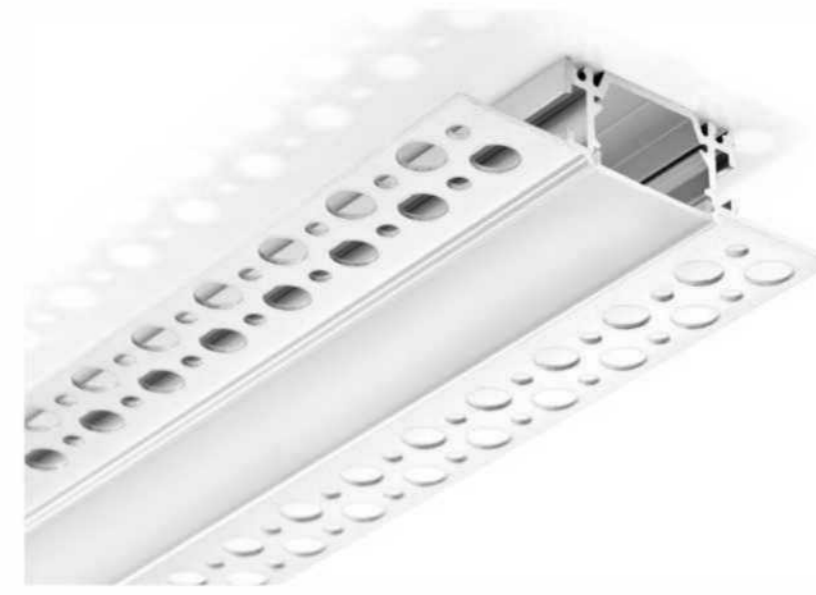

End caps

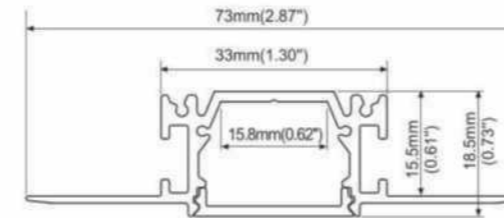

- PC diffused cover

ALP079

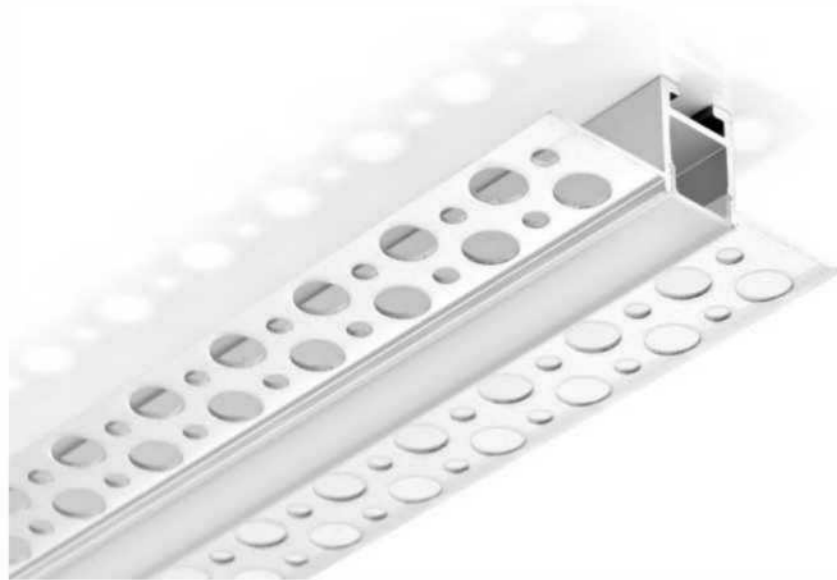

End caps

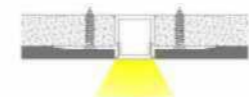
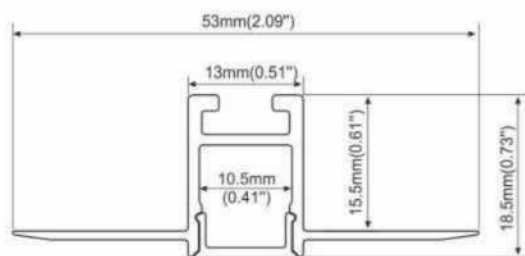

- PC diffused cover

ALP081-R

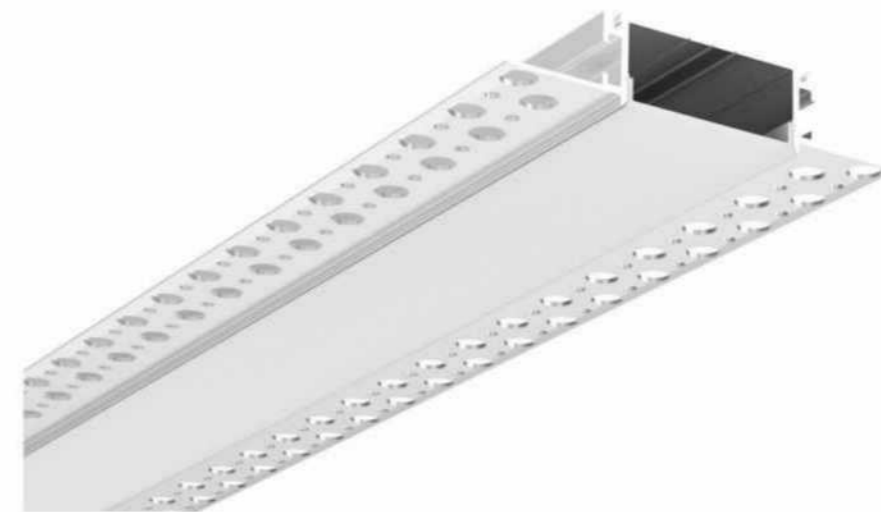

End caps



90° Outside connector



90° Inside connector



L connector

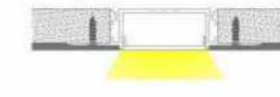
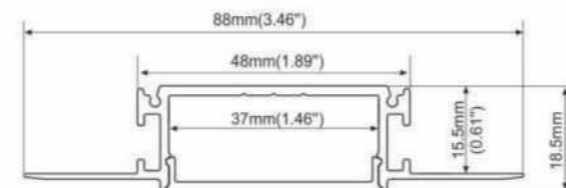

- PC diffused cover



• PC diffused cover

ALP082



End caps

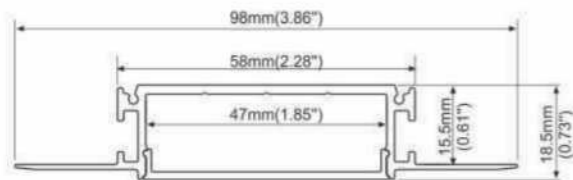

• PC diffused cover

ALP083-R



End caps



ALP081-R

Installation methods

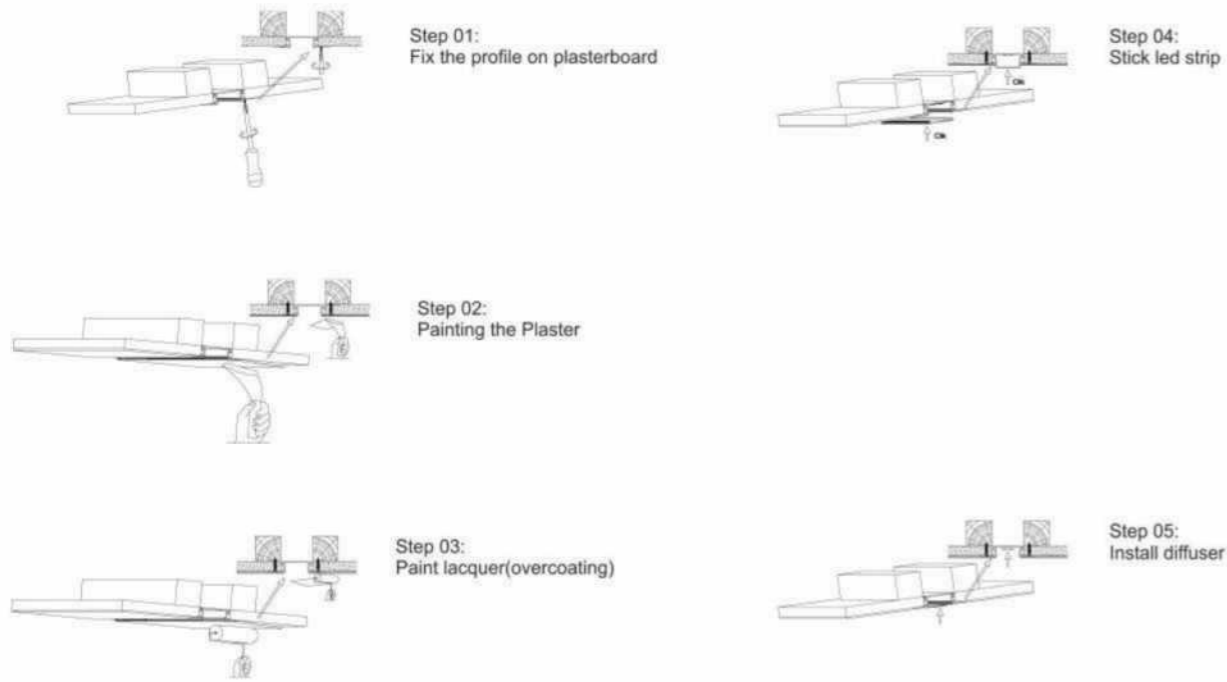

ALP082

Installation methods

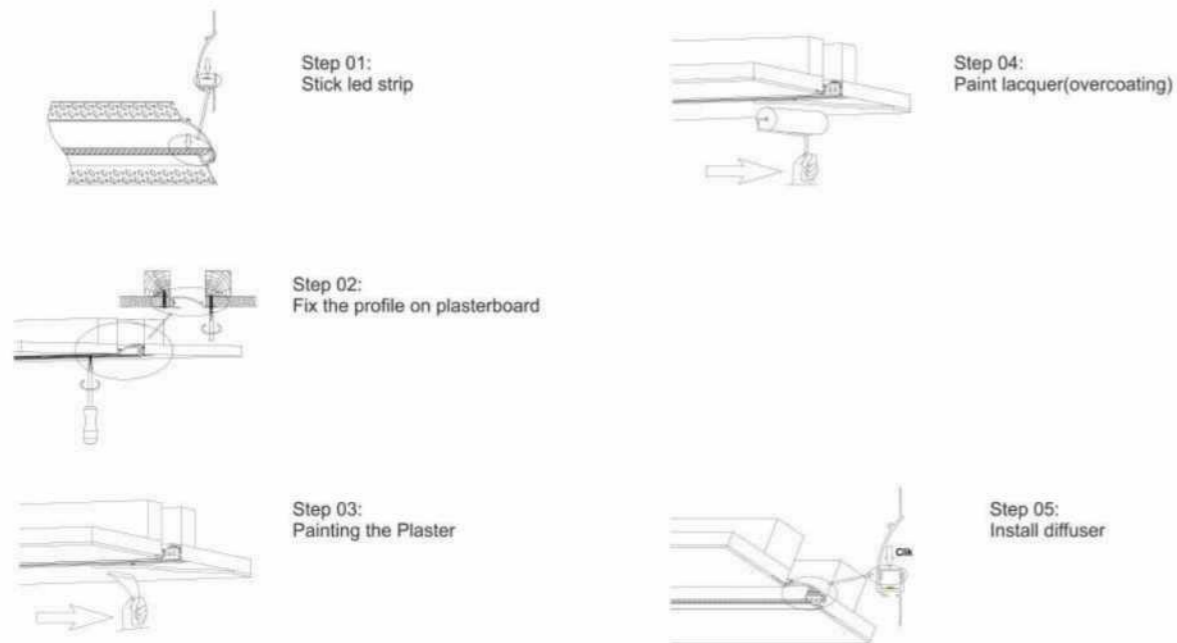

ALP085



ALP086

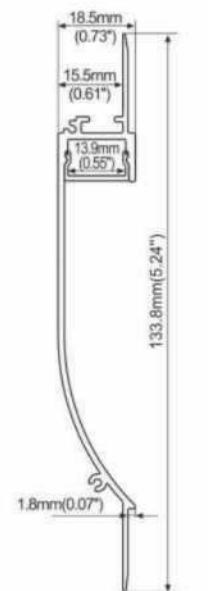

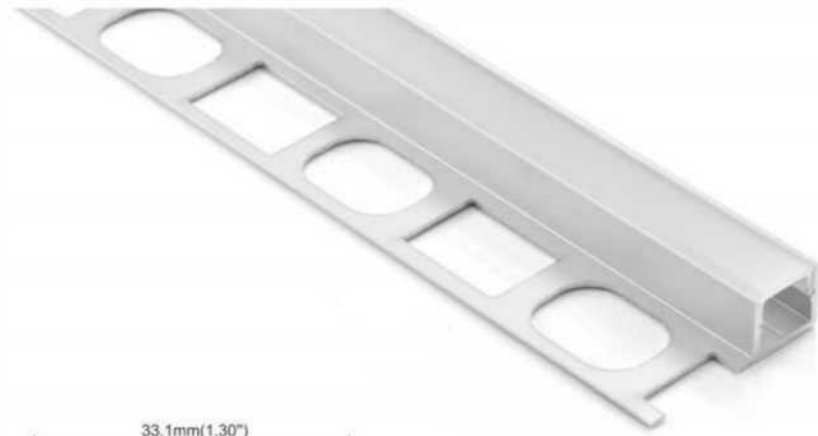

ALP087

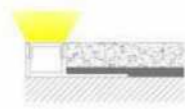
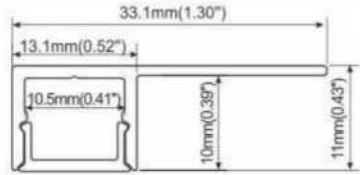

• PC diffused cover

ALP088

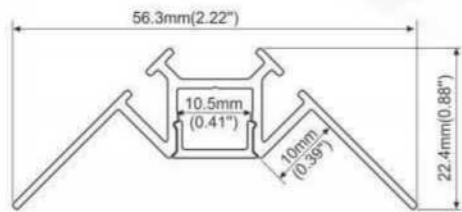
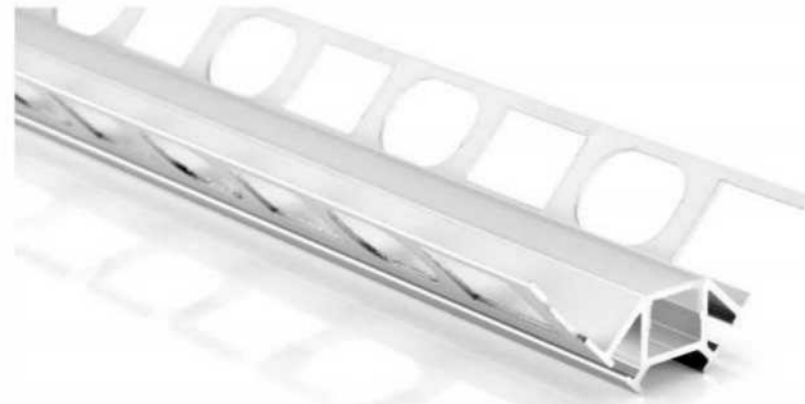

• PC diffused cover

ALP089

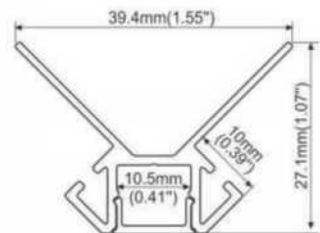

• PC diffused cover

ALP088

Installation methods



Step 01:
Painting cement mortar

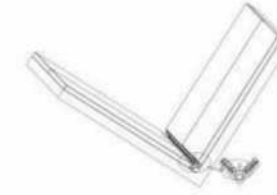

Step 04:
Stick led strip



Step 02:
Put the profile inside the corner



Step 03:
Stick the tile



Step 05:
Install diffuser

ALP089

Installation methods



Step 01:
Painting cement mortar



Step 04:
Stick led strip

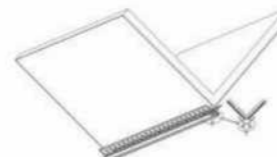

Step 02:
Put the profile inside the corner



Step 03:
Stick the tile



Step 05:
Install diffuser

ALP090

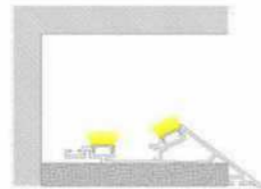
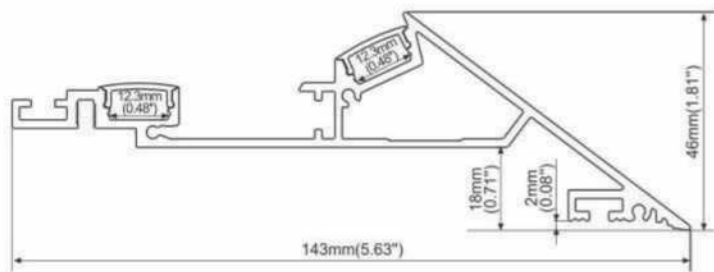

End caps

- PMMA semi-clear cover

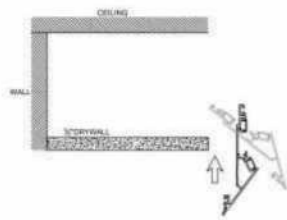

Step 01

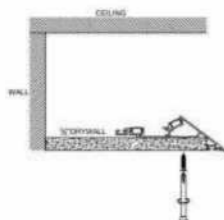

Step 02

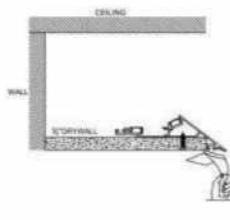

Step 03

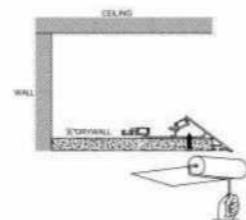

Step 04

ALP091-E

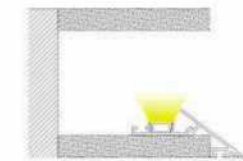
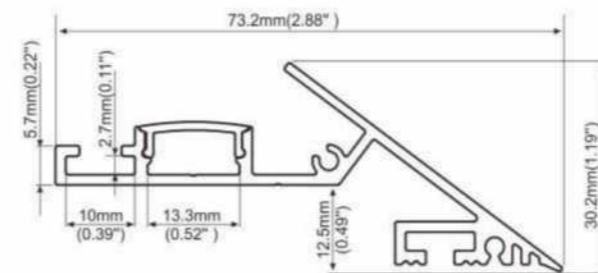

End caps

- PMMA semi-clear cover



ALP084

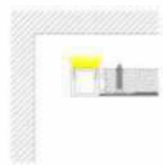
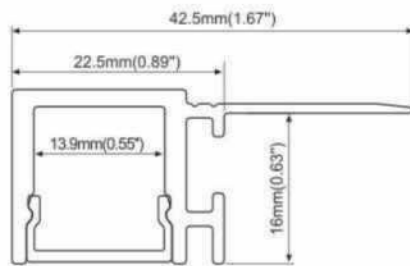

• PC diffused cover

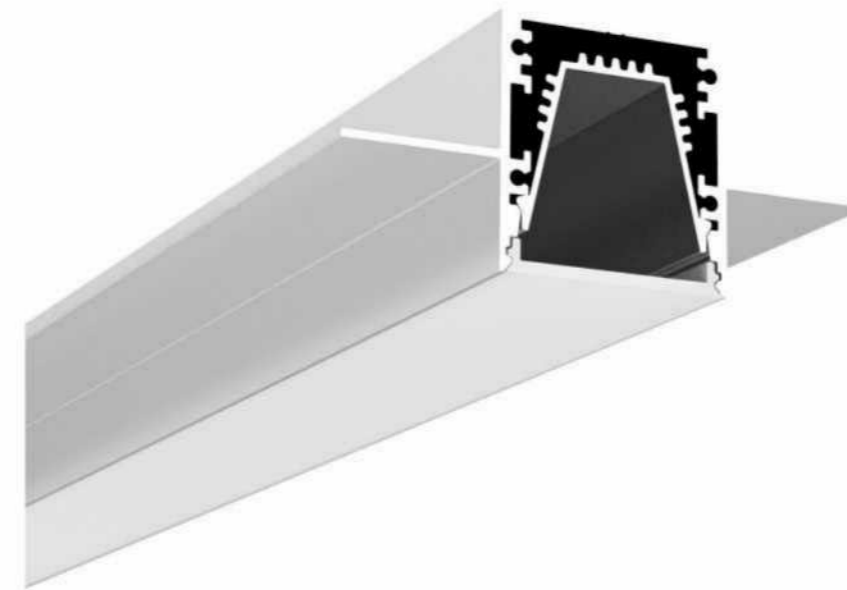

ALP3030-R

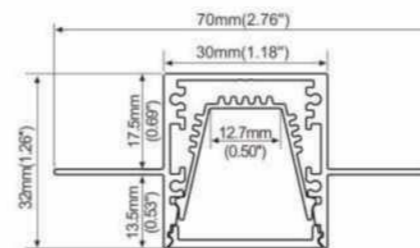

• PC frosted cover

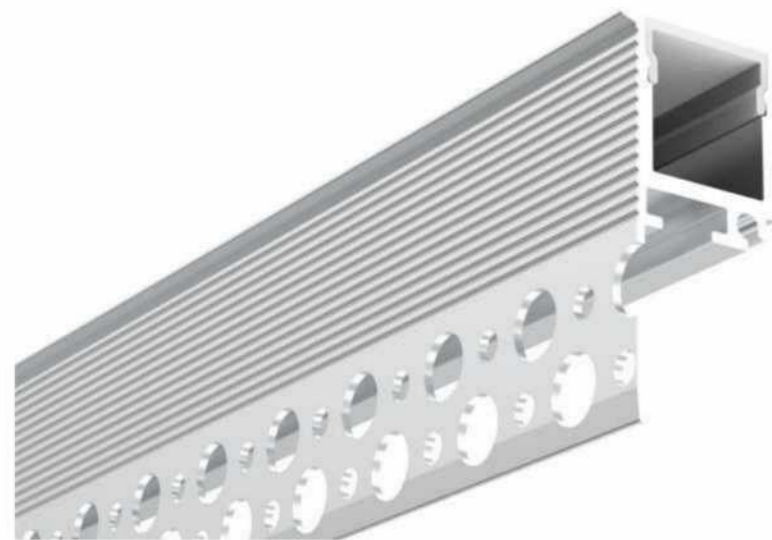

ALP084-S

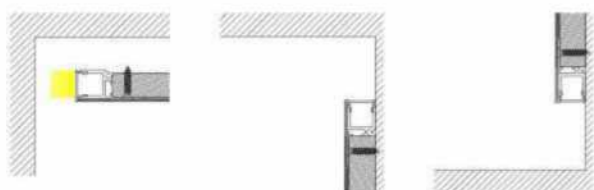
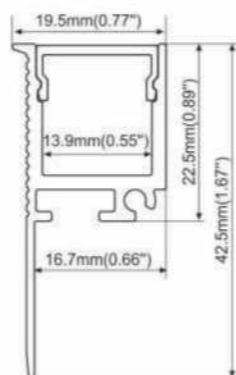

• PC diffused cover

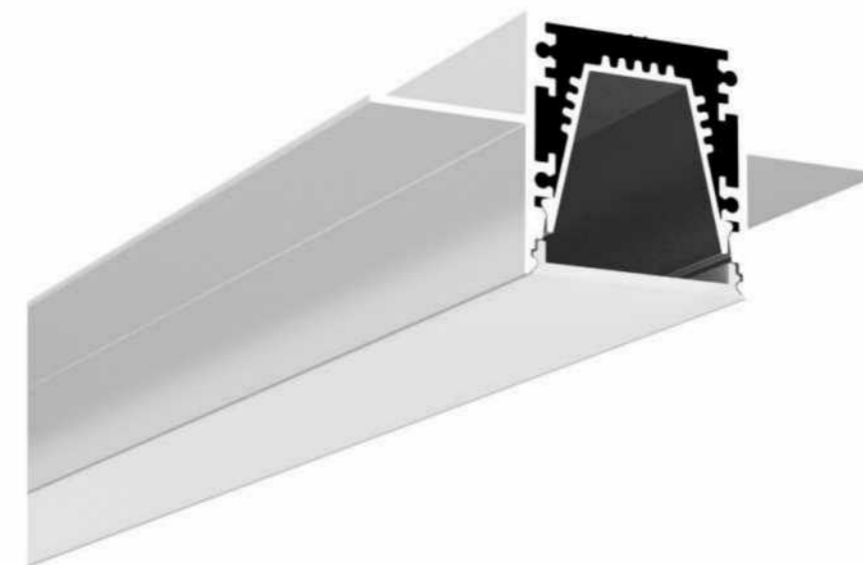

ALP3030-R2

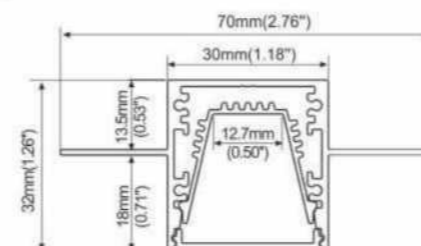

• PC frosted cover

ALP3030-R

Installation methods



Step 01

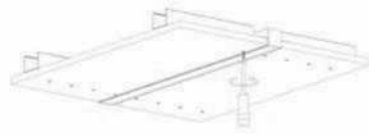

Step 05

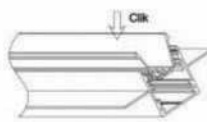

Step 02

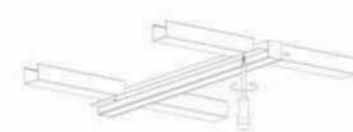

Step 06

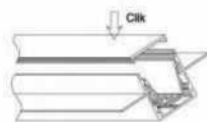

Step 03

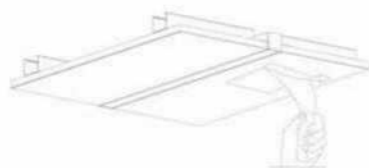

Step 07

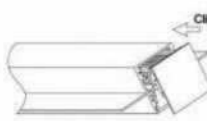

Step 04



Step 08

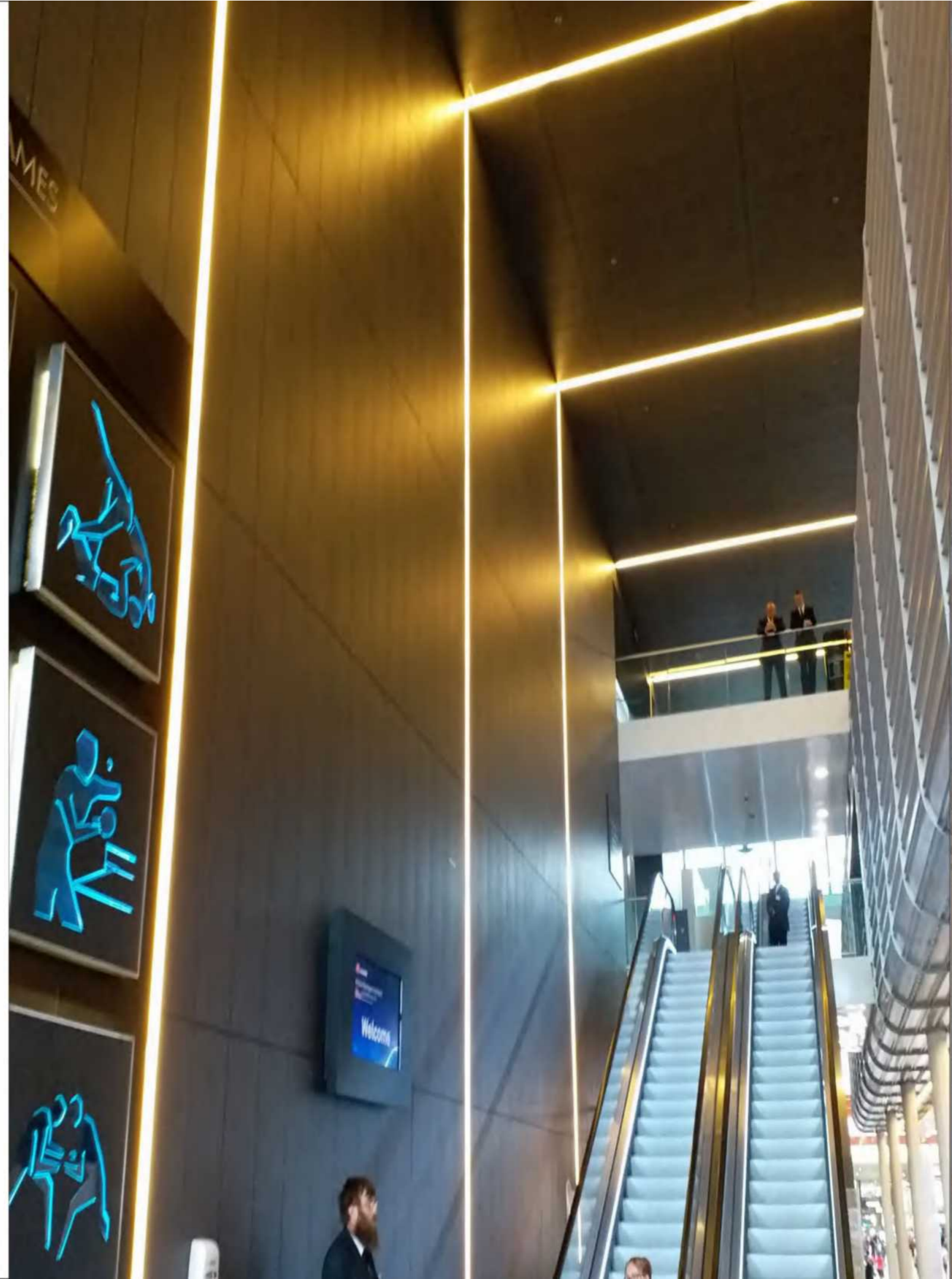

ALP092

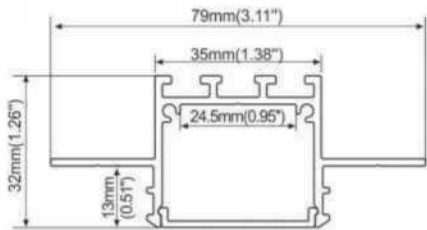

• PC diffused cover



ALP093

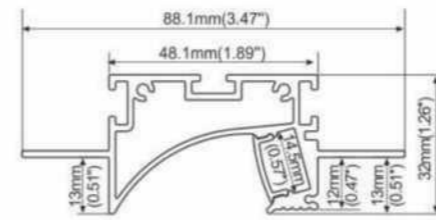

• PMMA semi-clear cover



Step 01



Step 02



Step 03



Step 04



Step 05



Step 06



Step 07



Step 08

ALP094

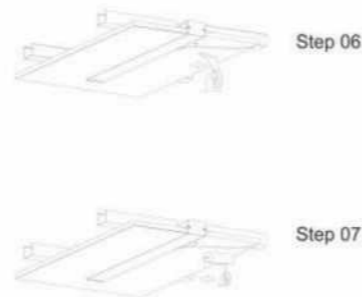
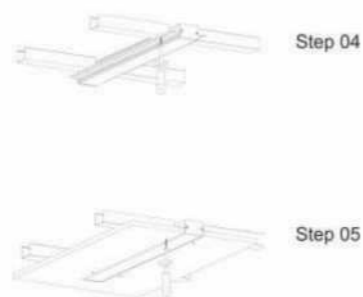
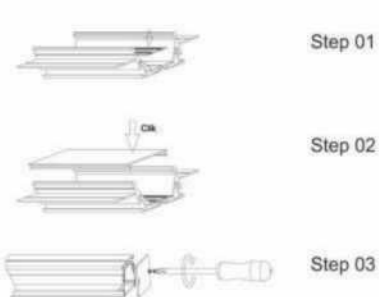
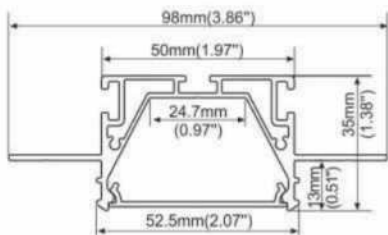

ALP095

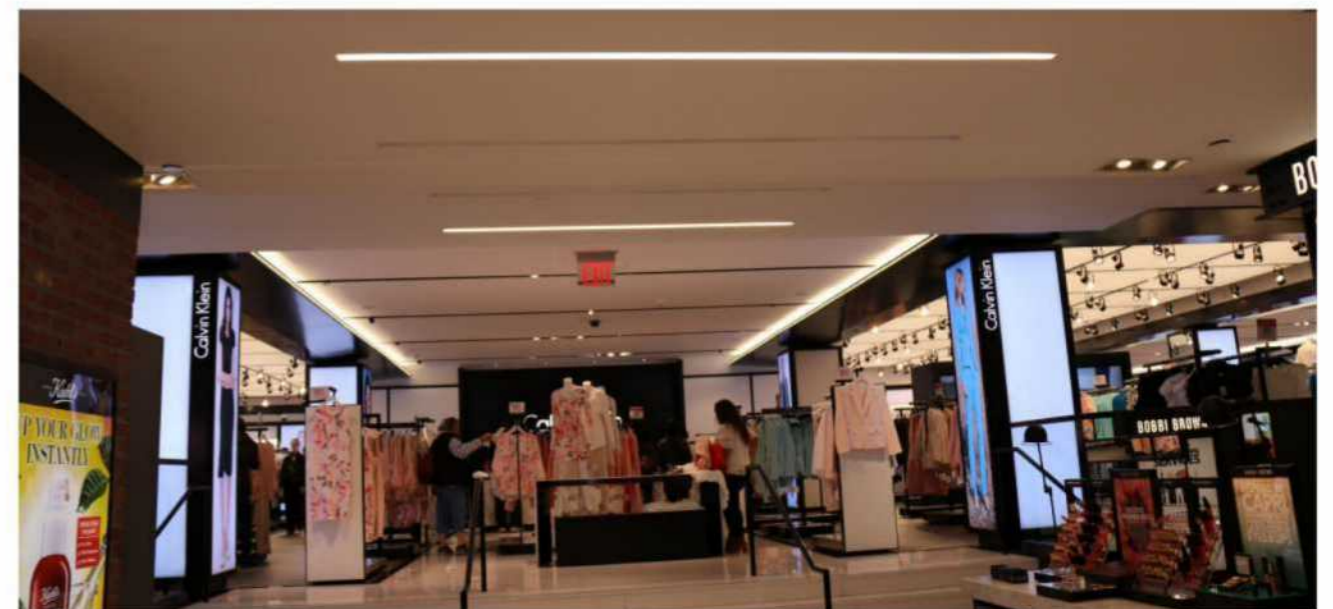
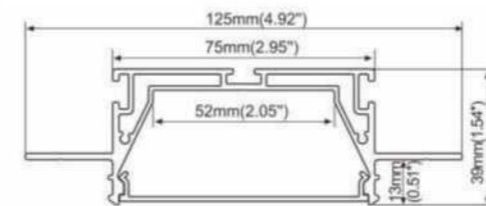

ALP110-S

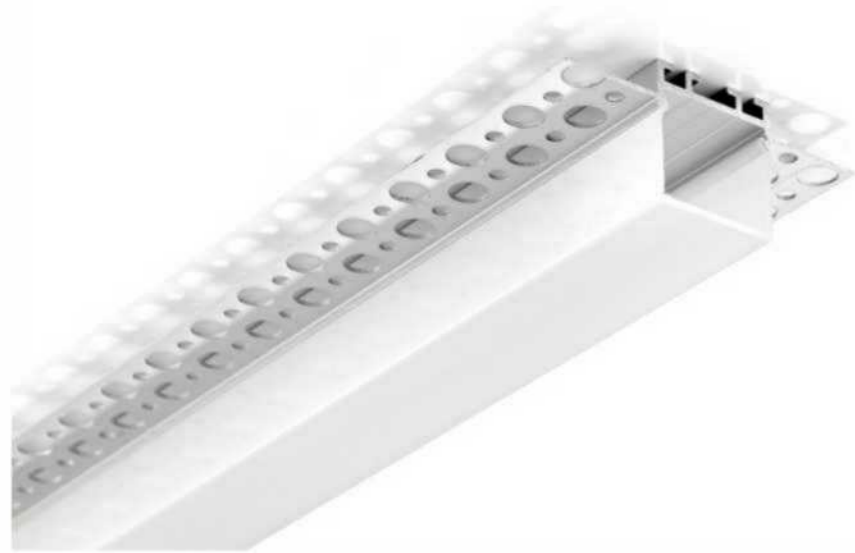

End caps

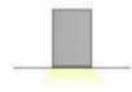
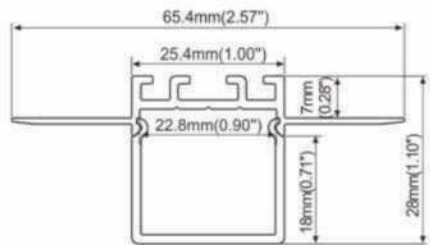

• PC diffused cover

ALP111-S



End caps



Clip

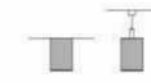
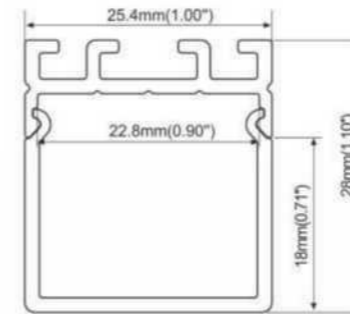

• PC diffused cover

ALP110-R



End caps

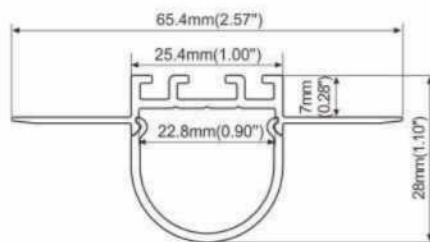

• PC diffused cover

ALP111-R



End caps



Clip

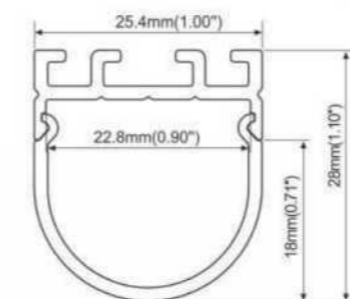

• PC diffused cover

ALP118

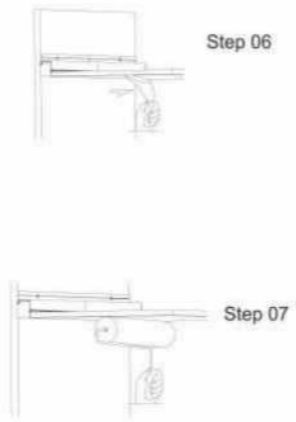
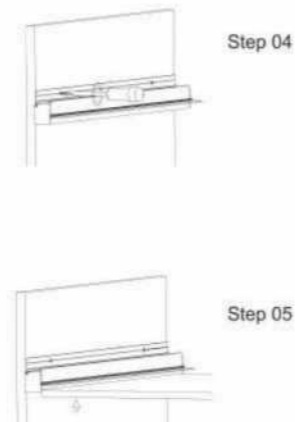
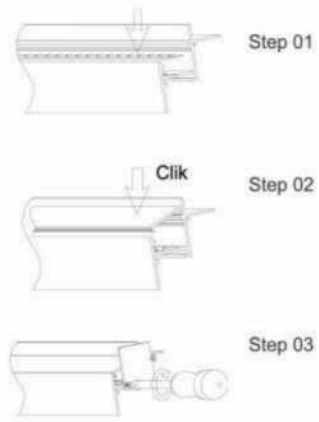
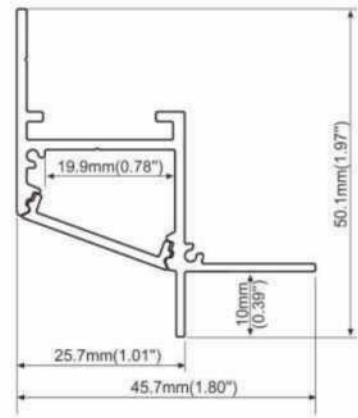

ALP078

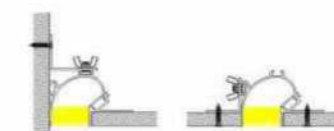
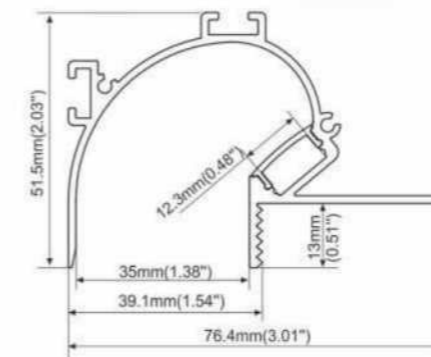
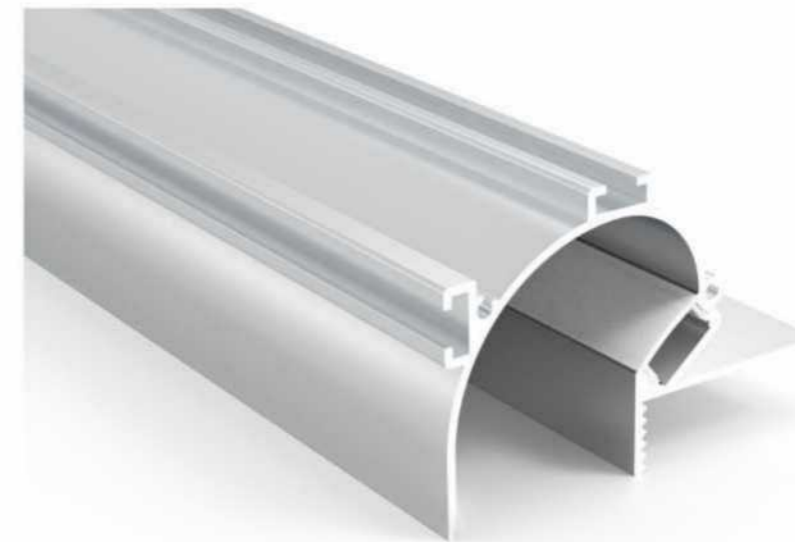
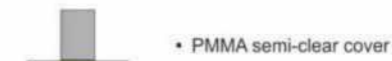
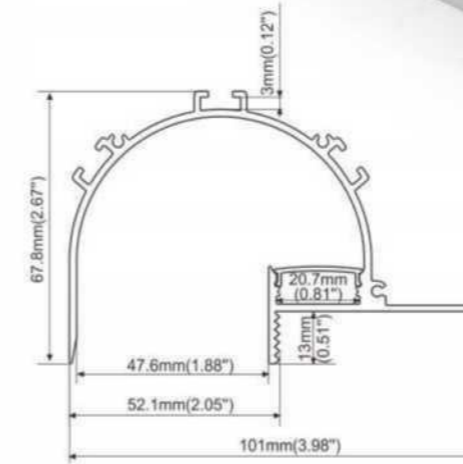

ALP078-R

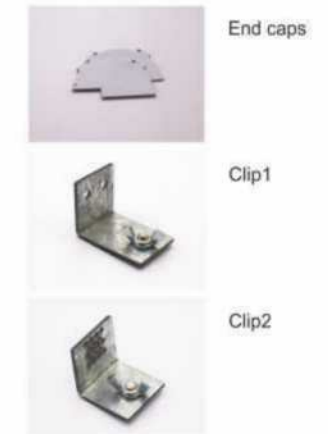



Step 01:
Stick led strip

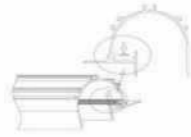

Step 05:
Fix the whole profile
on wooden frame



Step 02:
Push the diffuser inside

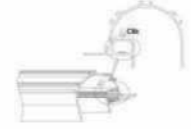

Step 06:
Install the ceiling
plasterboard

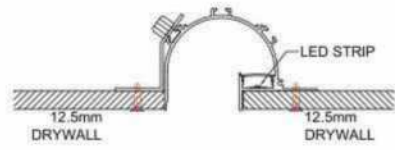
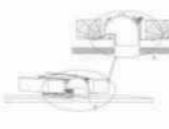

Step 03:
Fix the frame on profile



Step 07:
Paint the plaster



Step 04:
Fix end caps



Step 08:
Paint lacquer
(overcoating)



ALP126

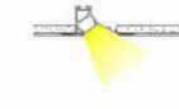
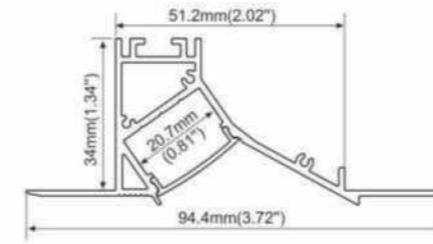
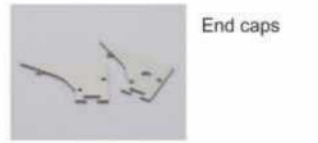

- PC diffused cover
- PC semi clear cover



Step 01

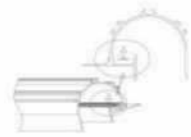

Step 06



Step 02

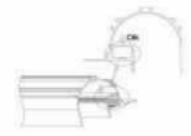

Step 07



Step 03



Step 08



Step 04



Step 09



Step 05

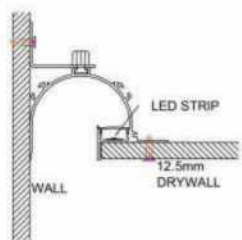

ALP127

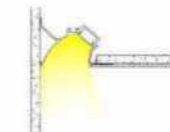
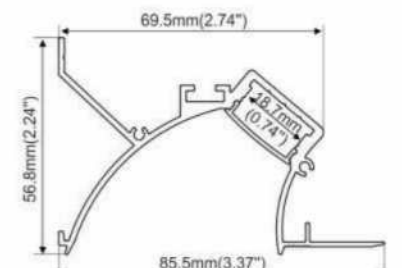
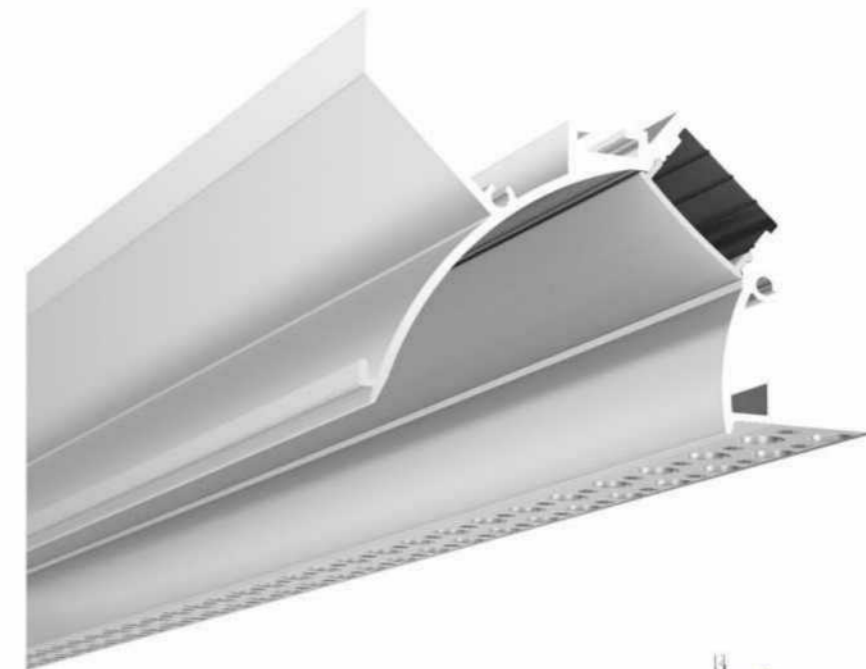
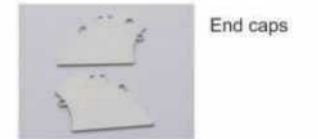

- PC diffused cover
- PC semi clear cover

ALP128



- PC diffused cover
- PC semi clear cover



End caps

ALP129

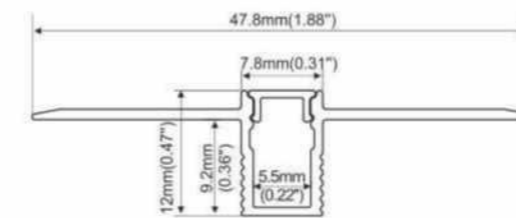

- PC frosted cover



End caps

ALP130

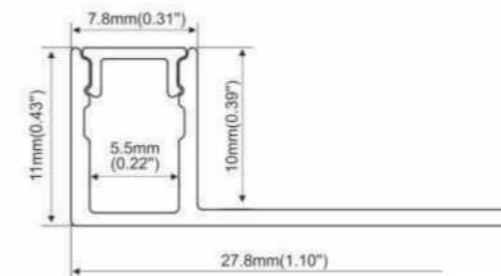
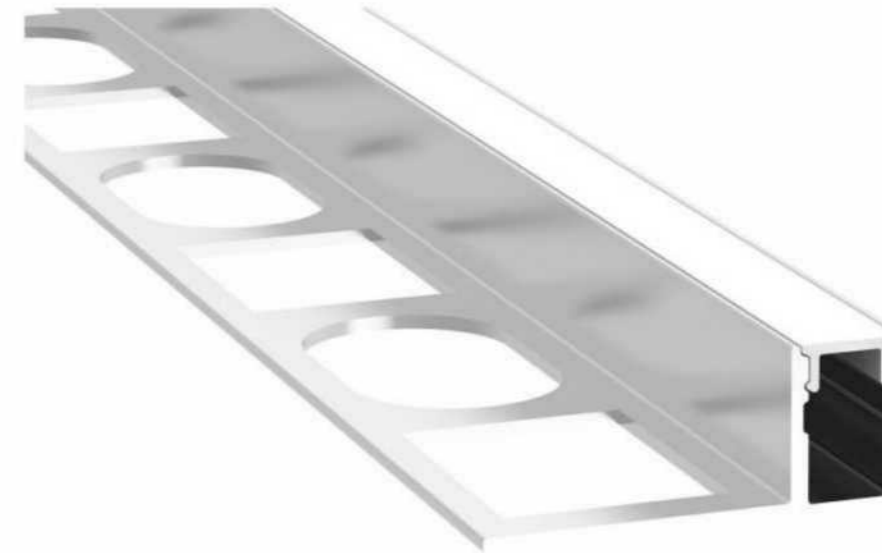

- PC frosted cover



End caps

ALP131

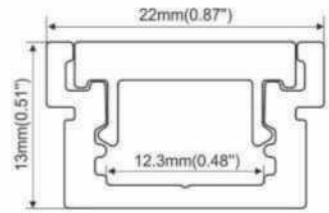
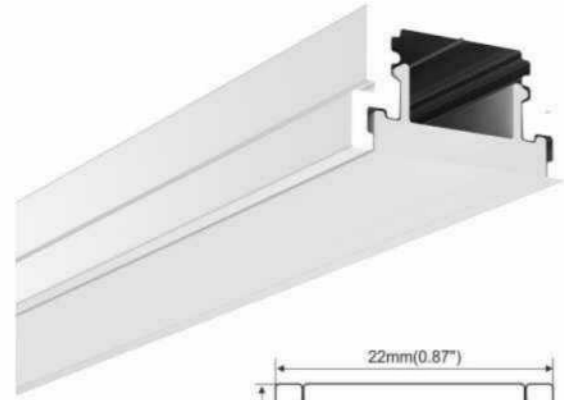

• PC diffused cover



End caps

ALP132

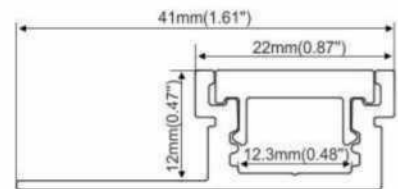

• PC diffused cover



End caps

ALP133

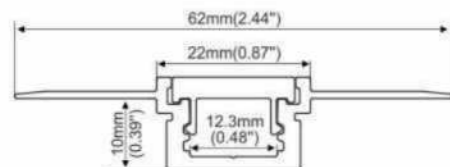

• PC diffused cover



End caps

ALP033

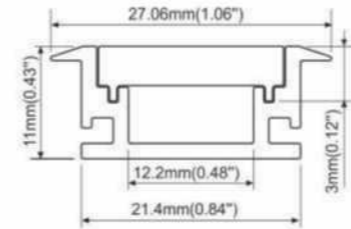

• PC diffused cover



End cap with hole
End cap without hole

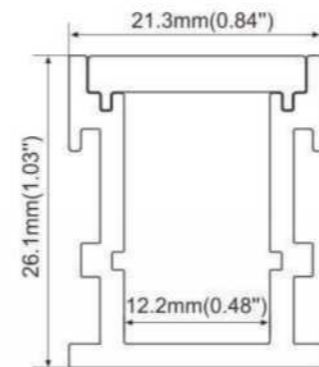

• PC diffused cover

ALP034

End cap with hole
End cap without hole

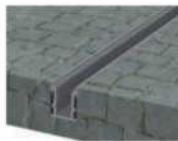

Step 01

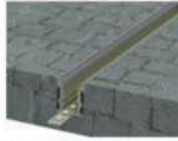





Step 02



Step 03



S1018-S

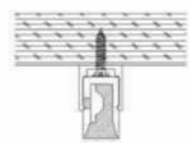
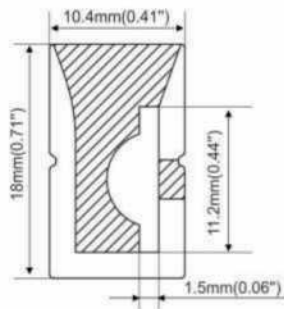

-  Aluminum profile for mounting
-  End caps
-  Mounting clip
-  Bendable profile for mounting



- 10mm PCB
- 14W at maximum

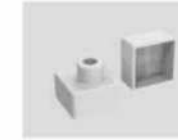

S1616-S



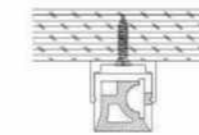
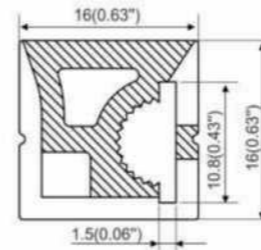

-  Aluminum profile for mounting
-  End caps
-  Mounting clip(metal)
-  Bendable profile for mounting



- 10mm PCB
- 14W at maximum



S1616-T

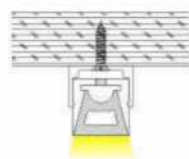
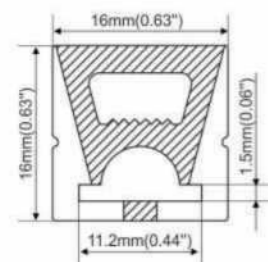

-  Aluminum profile for mounting
-  End caps
-  Mounting clip(metal)
-  Bendable profile for mounting



- 10mm PCB
- 14W at maximum



S1616-C

-  End cap with hole
-  End cap without hole
-  Mounting clip(metal)

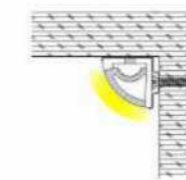
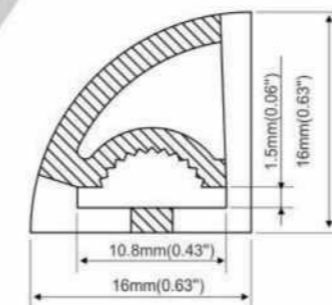

- 10mm PCB
- 14W at maximum



S0410-S

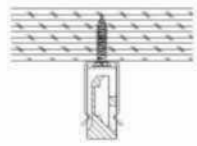
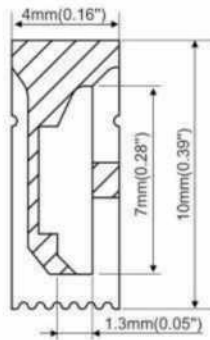

- 6mm PCB
- 14W at maximum

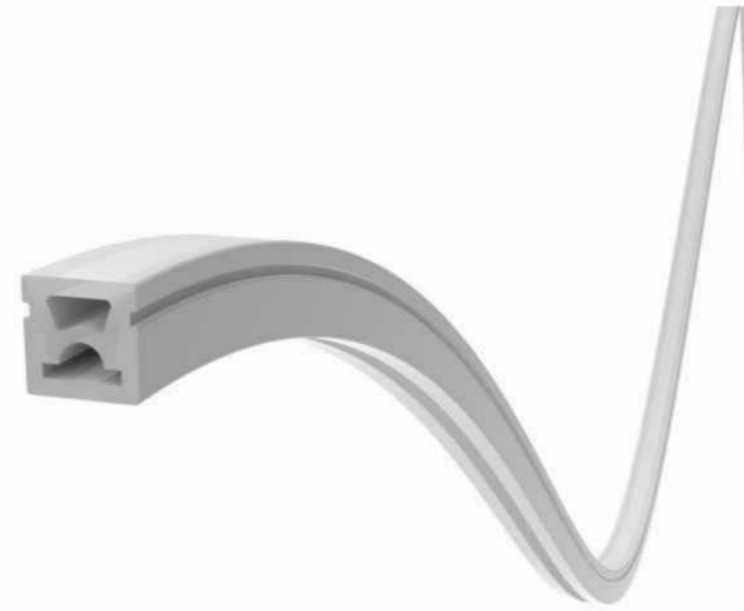

S1010-T

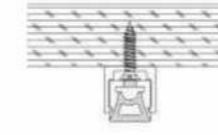
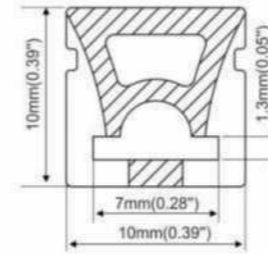
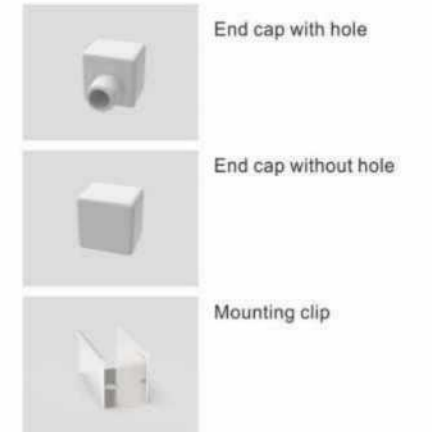

- 6mm PCB
- 14W at maximum



S0612-S

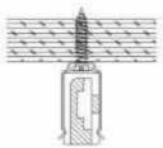
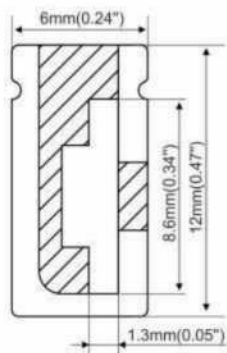

- 8mm PCB
- 14W at maximum



S3021-T

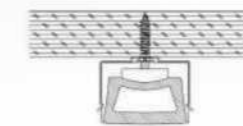
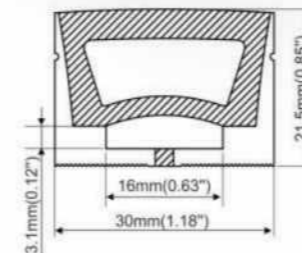
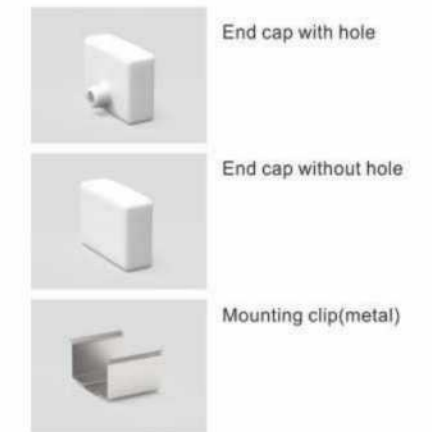

- 15mm PCB
- 14W at maximum

S20

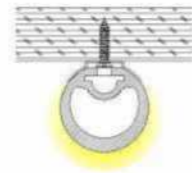
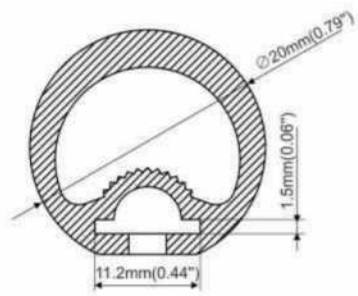
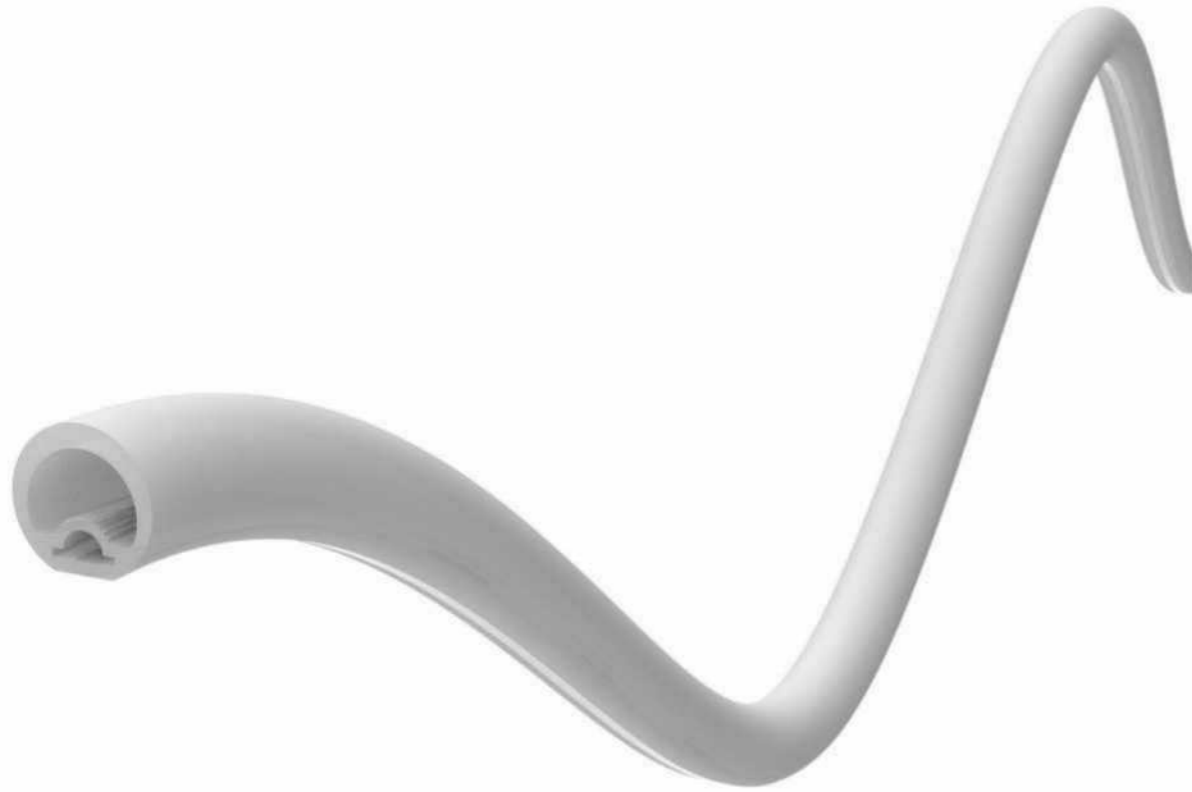

- 10mm PCB
- 14W at maximum



End cap with hole



End cap without hole

LS30

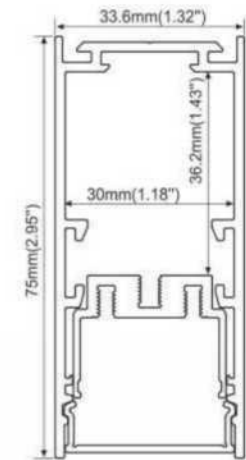

End caps



Blind cover



Reflector: 15°, 30°, 45°



Inside clip



LED module



90 degrees connector



Outside clip



Steel wire



180 degrees connector



PC frosted cover



Safety wire

LS30

Free combination

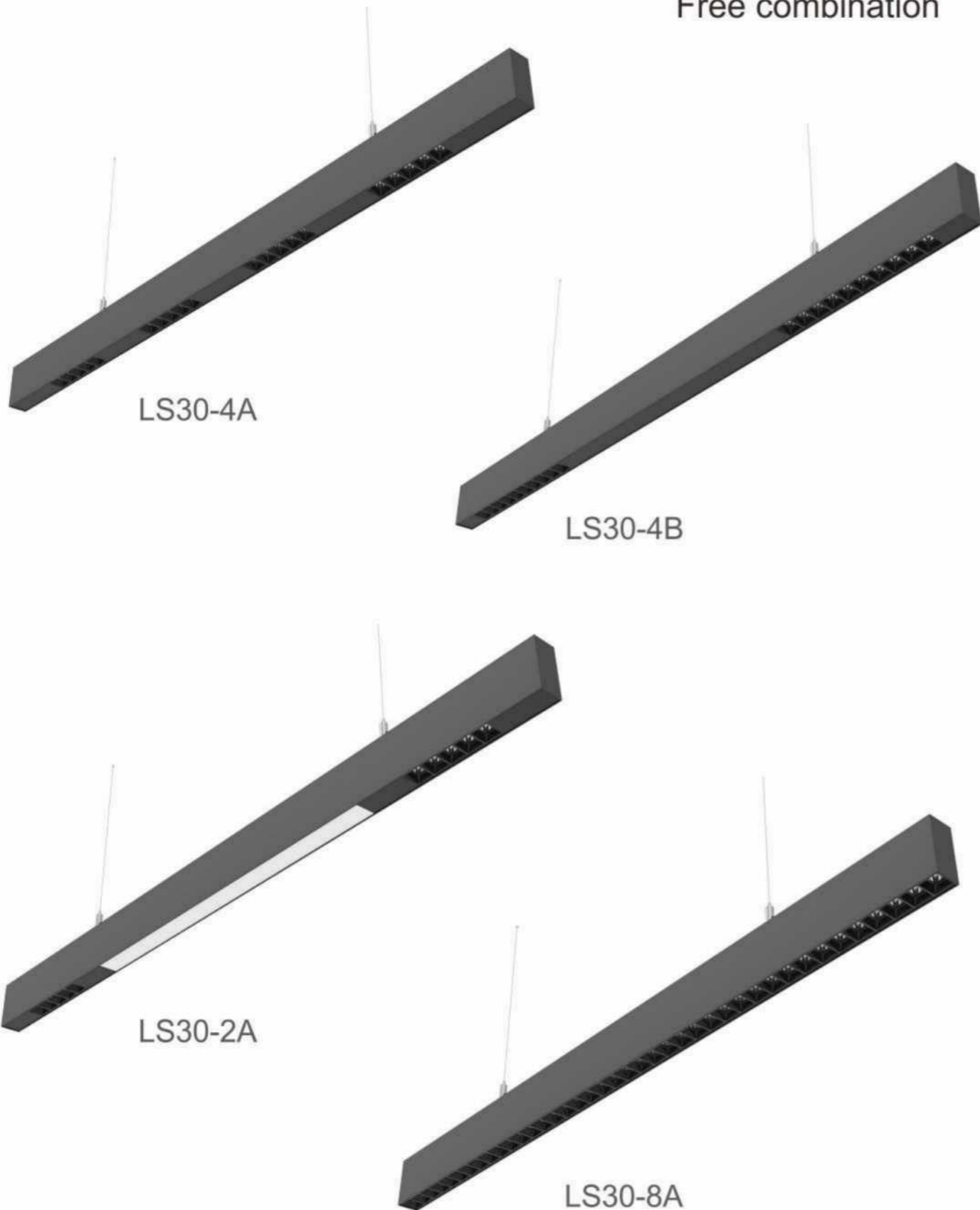

LS30

Installation methods



Step 01:
Install the end caps



Step 02:
Fix the led module



Step 03:
Fix the reflector



Step 04:
Fix the internal clips
and the driver

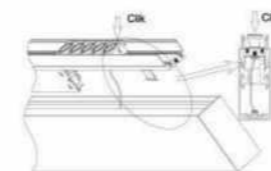

Step 05:
Fix the gear tray
and the safety wire

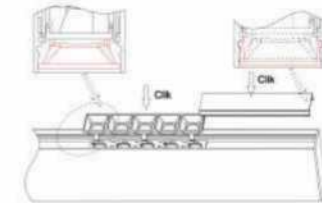

Step 06:
Push the anti-glare cover
and blind cover inside

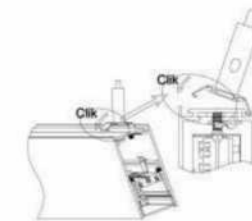

Step 07:
Fix the external clip



Step 08:
Fix the steel wire



Step 09:
Installation completed

LS30-T

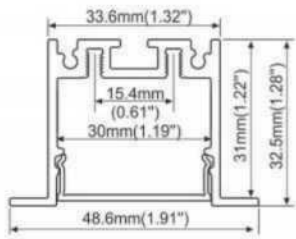

-  End caps
-  PC frosted cover
-  Spring clip
-  Blind cover
-  Reflector: 15°, 30°, 45°

LS30-T

Installation methods



Step 01:
Fix the led module



Step 02:
Fix the reflector

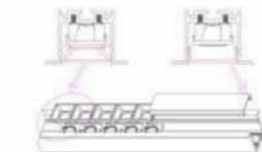

Step 03:
Push the anti-glare cover and blind cover inside



Step 04:
Slide the spring clip inside



Step 05:
Fix the spring clip



Step 06:
Install the end caps



Step 07:
Push the whole profile into the ceiling



Step 08:
Installation completed

LS30-TS

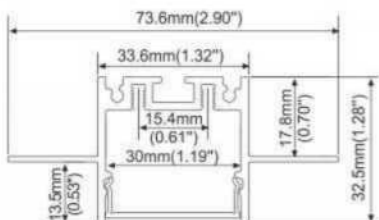

-  End caps
-  PC frosted cover
-  Blind cover
-  Reflector: 15°, 30°, 45°

LS30-TS

Installation methods



Step 01:
Fix the led module



Step 02:
Fix the reflector

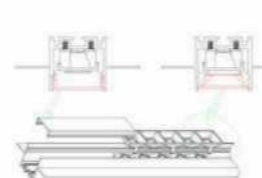

Step 03:
Push the anti-glare cover and blind cover inside



Step 04:
Install the end caps

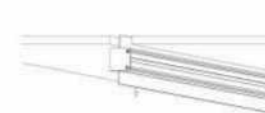

Step 05:
Put the whole profile on the top of the ceiling

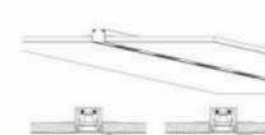

Step 06:
Painting the Plaster and lacquer

LS40

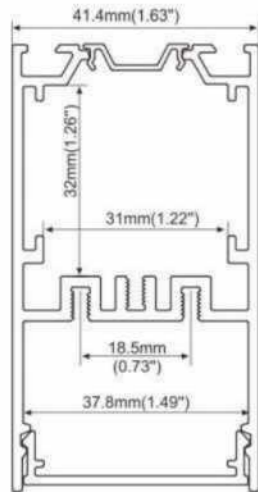
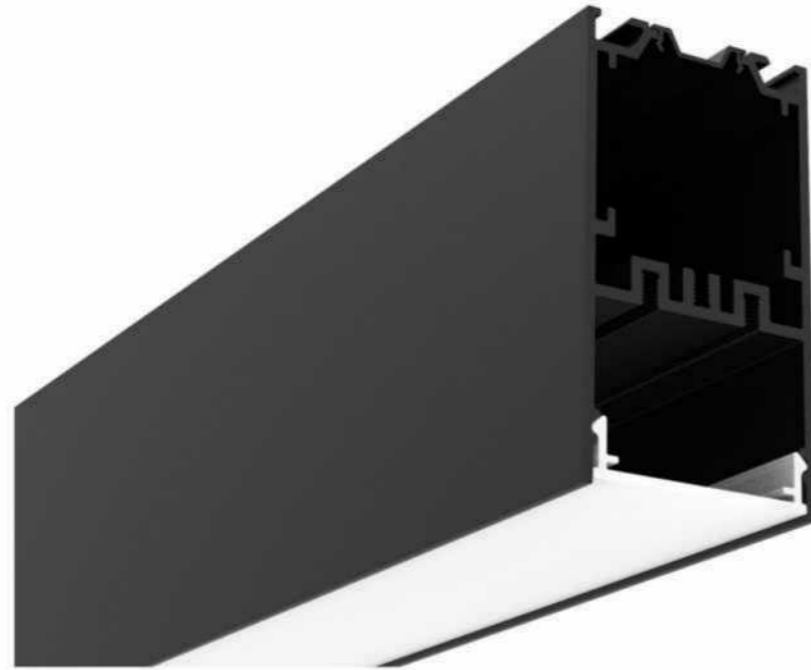

Optics:

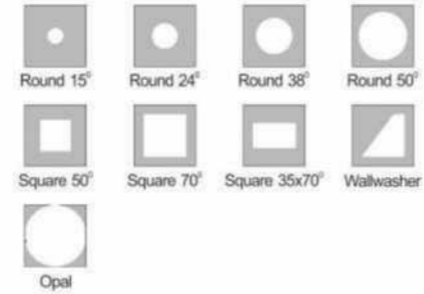

Light Source: OSRAM LED
Installation: Suspended or Surface



Free combination

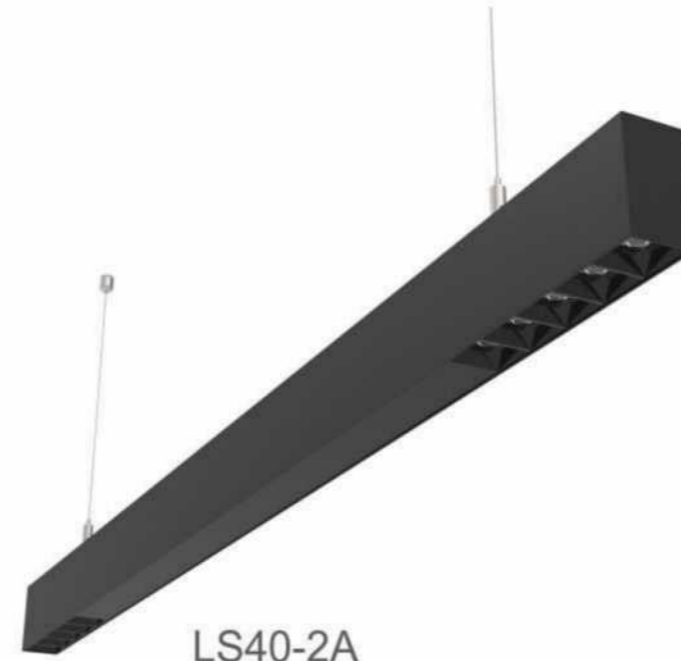

LS40-2A

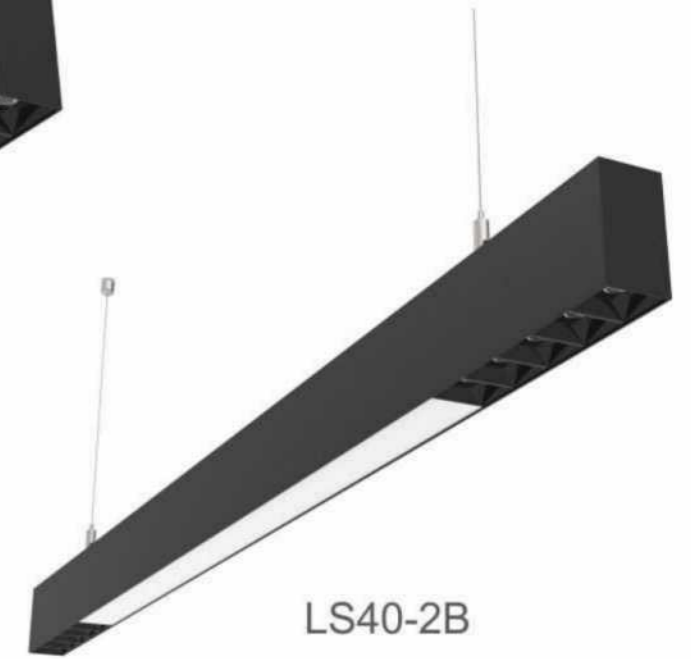

LS40-2B

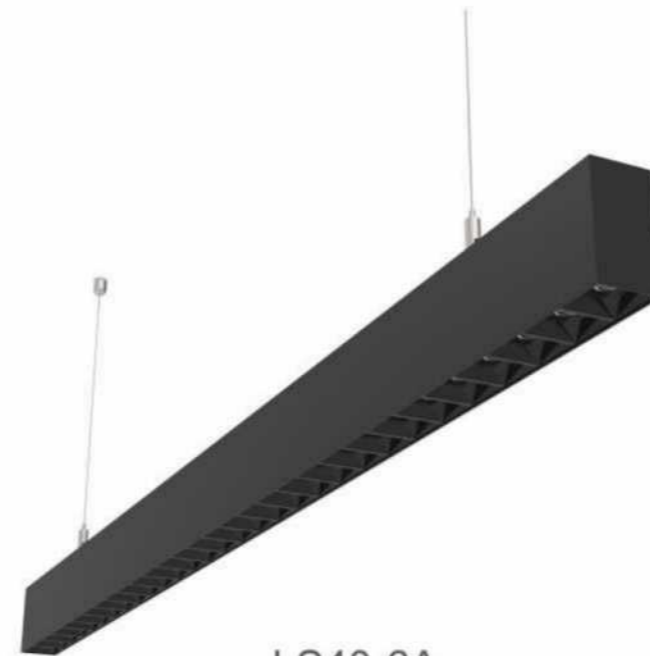

LS40-6A



LS40-PC

LS40-2A

Installation methods



Step 01:
Lock the end caps

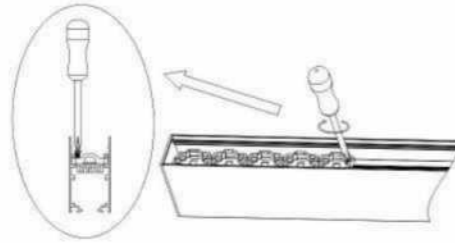

Step 02:
Fix the base of the reflector

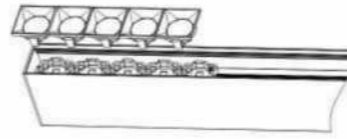

Step 03:
Snap the reflector on the top of the base



Step 04:
Press the blind cover into the profile



Step 05:
Fix the driver on the back of the profile



Step 06:
Press the aluminum cover into the backside

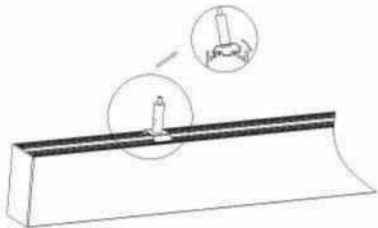

Step 07:
Install the outside clip

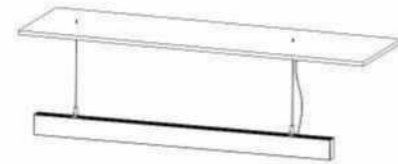

Step 08:
Hang the fixtures on the ceiling

LS40-T



End caps



Spring clip

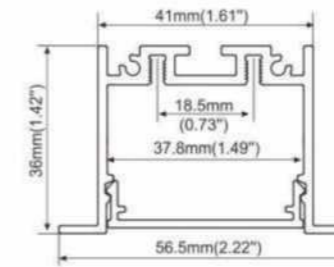

Optics:



Light Source:OSRAM LED
Installation:Recessed with flange

LS40-S



End caps

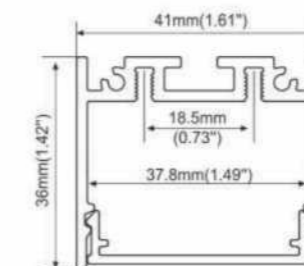
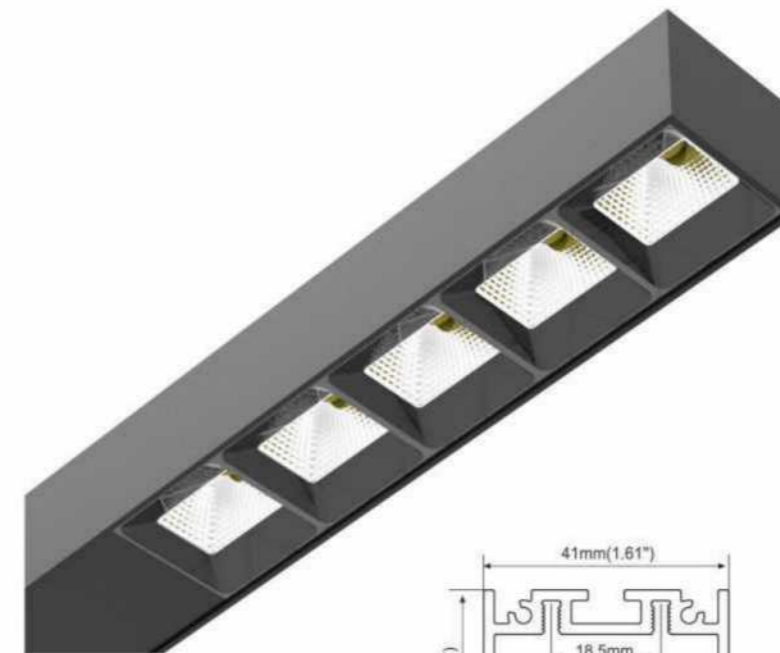

Optics:

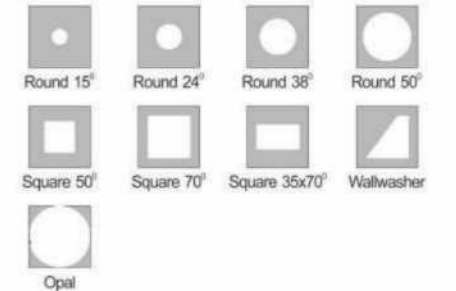

Light Source:OSRAM LED
Installation:Suspended or Surface

LS40-TS

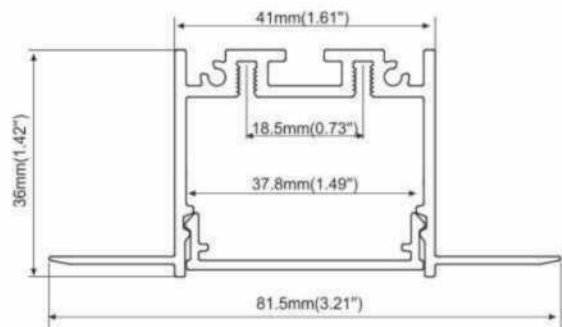
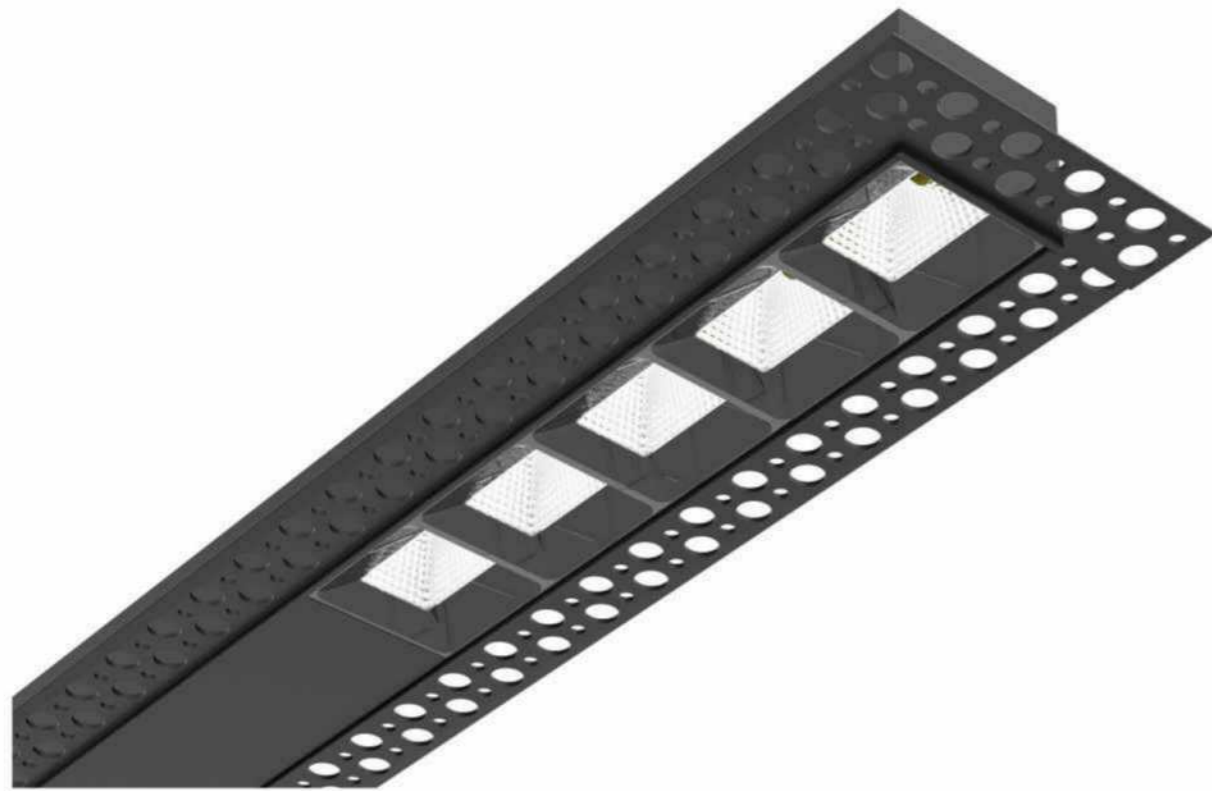

Optics:

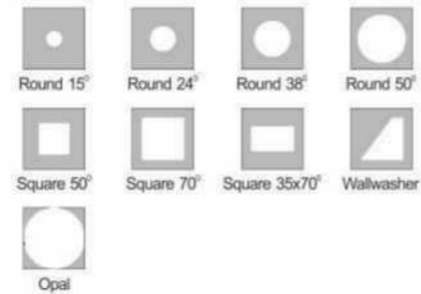

Light Source: OSRAM LED
Installation: Trimless Recessed



End caps

LS50

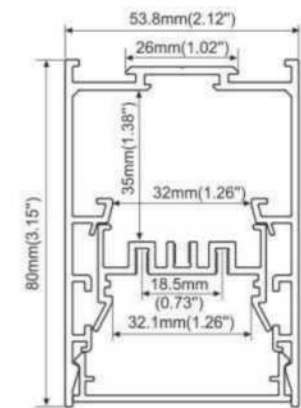

	CNC end caps without hole		Prismatic cover		reflector: 15°, 30°, 45°
	Inside clip		PC frosted cover		Wall washer
	Outside clip		Blind cover		High reflective louver
	LED module		Steel wire		Safety wire
	90° Connector		180° Connector		Internal clip
	Prismatic 3 in 1		Prismatic+Lens		

LS50

Free combination

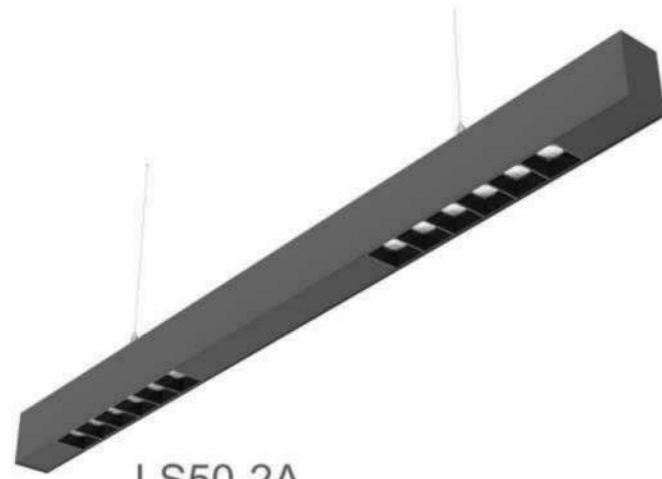

LS50-2A

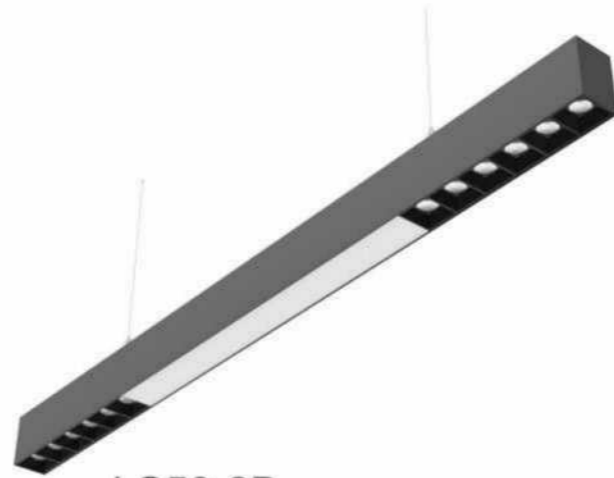

LS50-2B

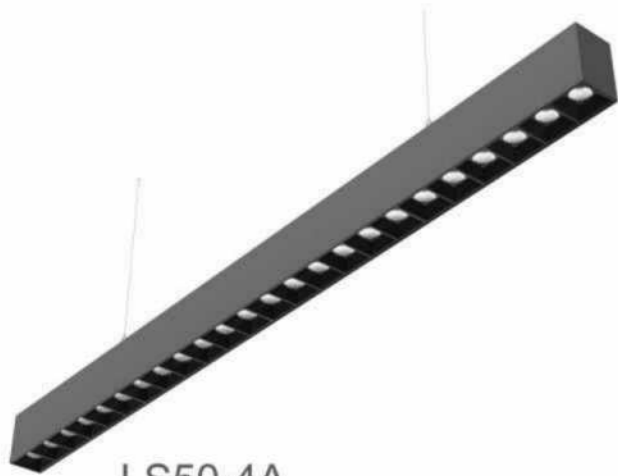

LS50-4A



LS50-Wall Washer

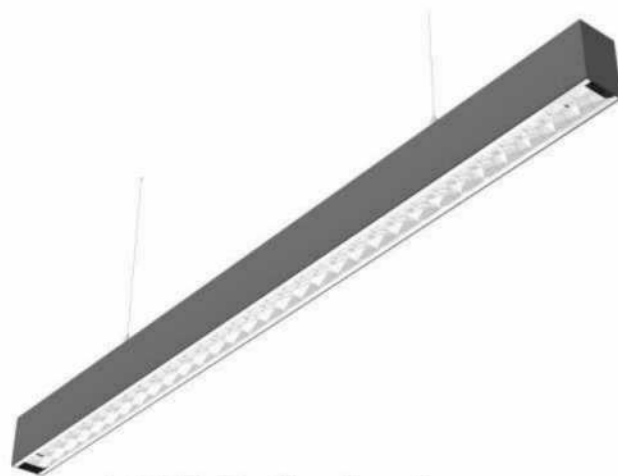

LS50-Reflective Louver

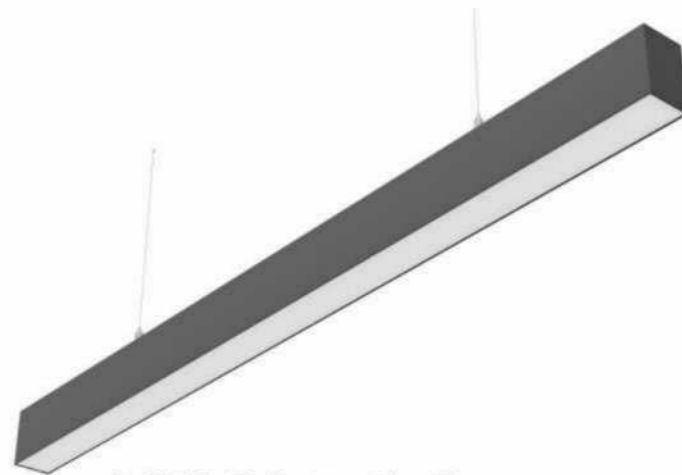

LS50-Prismatic Cover

LS50

Installation methods

Installation with reflector



Step 01:
Install the end caps



Step 02:
Fix the led module



Step 03:
Fix the reflector



Step 04:
Fix the internal clips
and the driver

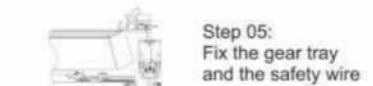

Step 05:
Fix the gear tray
and the safety wire

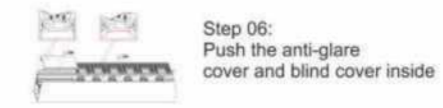

Step 06:
Push the anti-glare
cover and blind cover inside



Step 07:
Fix the external clip



Step 08:
Fix the steel wire



Step 09:
Installation completed

Installation with reflective louver



Step 01:
Install the end caps



Step 02:
Fix the led module

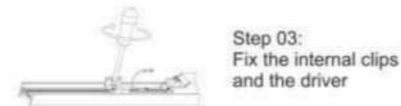

Step 03:
Fix the internal clips
and the driver



Step 04:
Fix the gear tray
and the safety wire



Step 05:
Insert the diffuser

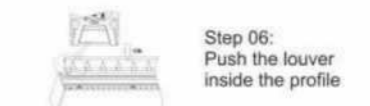

Step 06:
Push the louver
inside the profile



Step 07:
Fix the external clip



Step 08:
Fix the steel wire



Step 09:
Installation completed

Installation with wall washer



Step 01:
Install the end caps



Step 02:
Fix the led module and
press the diffuser inside



Step 03:
Fix the internal clips
and the driver



Step 04:
Fix the gear tray
and the safety wire



Step 05:
Fix the external clip



Step 06:
Fix the steel wire



Step 07:
Installation completed

LS50-T

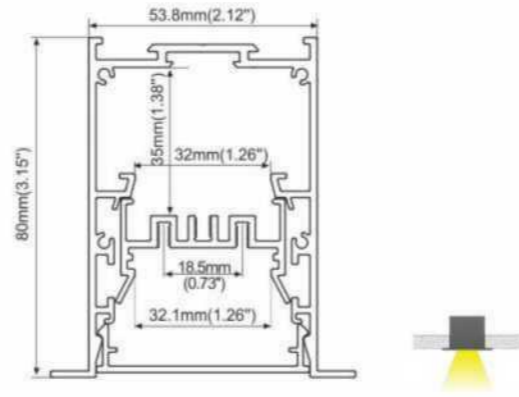
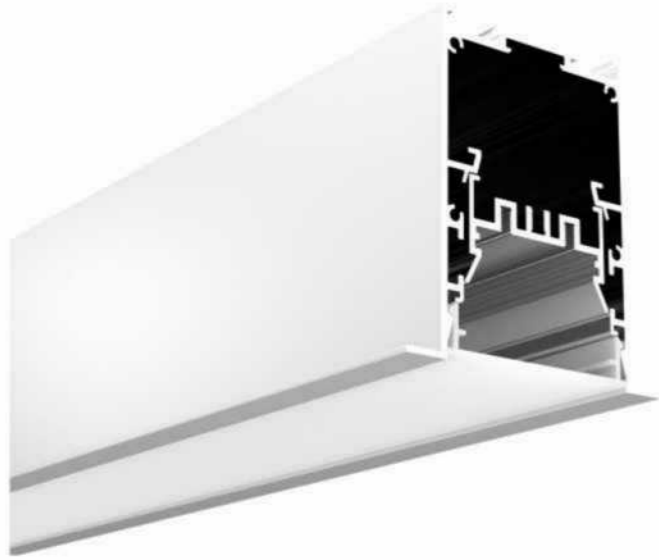

End caps

All of the accessories will be the same with LS50 except END CAPS

LS50-T1

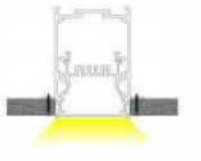
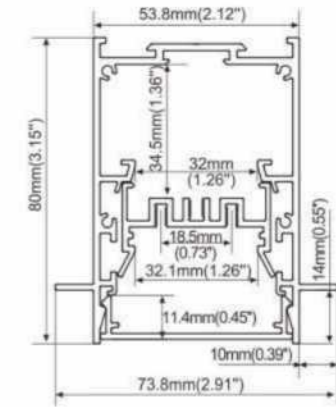
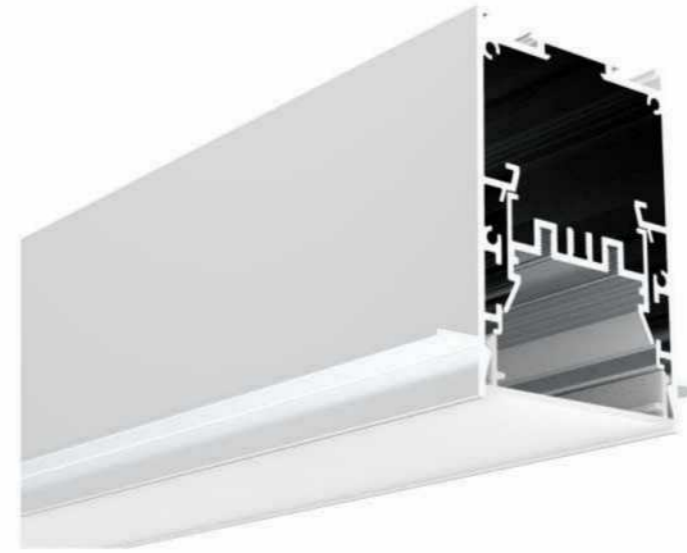

End cap without hole

All of the accessories will be the same with LS50 except END CAPS

LS50-TS

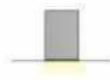
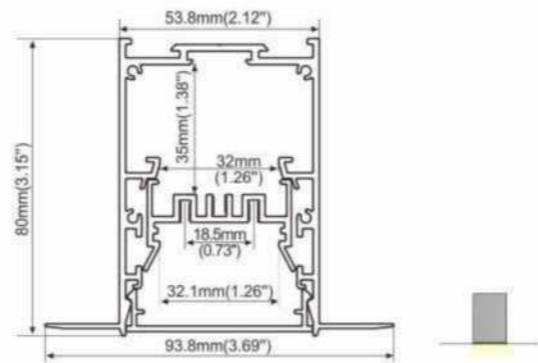
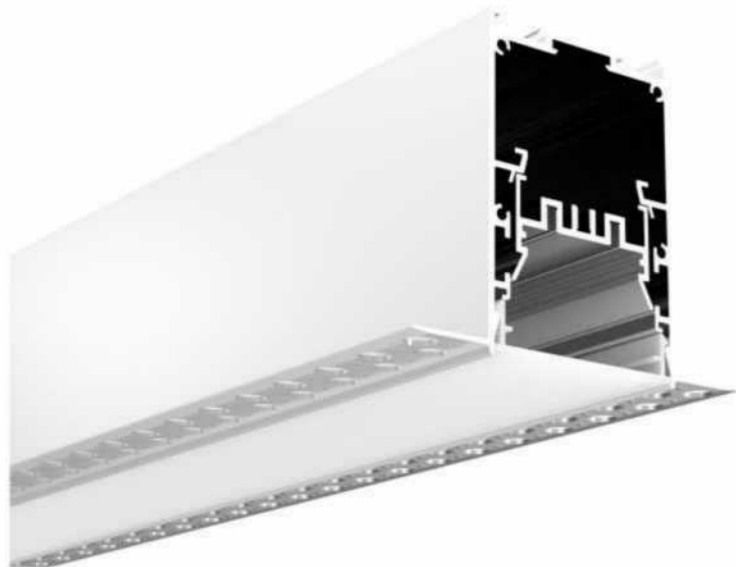

End caps

All of the accessories will be the same with LS50 except END CAPS

LS50-U

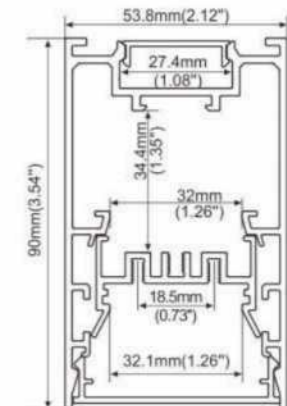
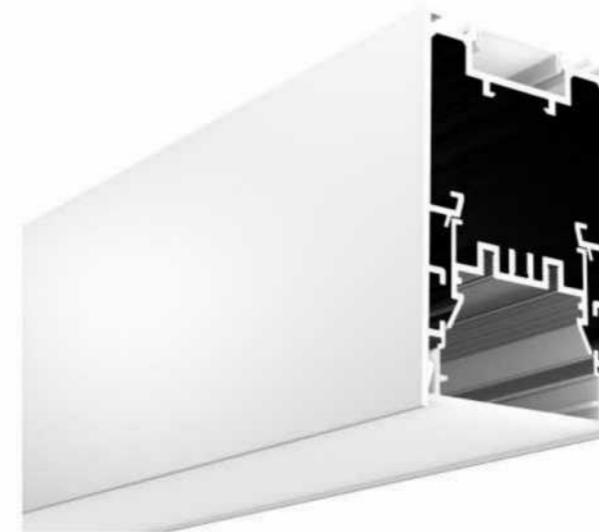

End caps



Hanging clip

All of the accessories will be the same with LS50 except END CAPS



Circles

ALP25C-R

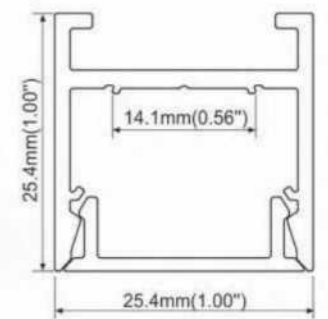
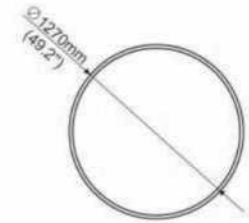
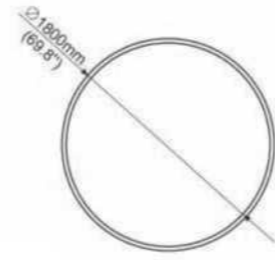
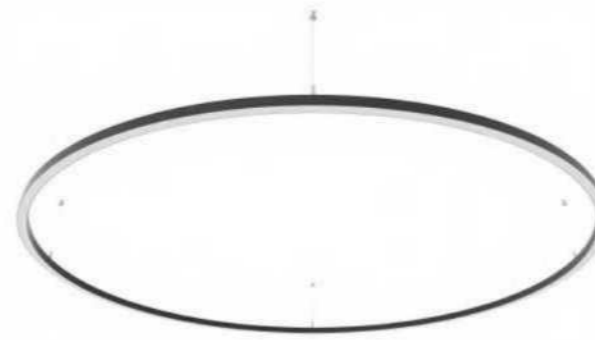

• PMMA opal matte cover



Connector



Steel wire



Curve led board 600mm

ALP25C-R

Installation methods

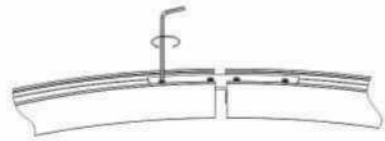

Step 01:
Connecting the curved profile by connector



Step 02:
Stick the led board inside the profile



Step 03:
Press the curved cover into the profile

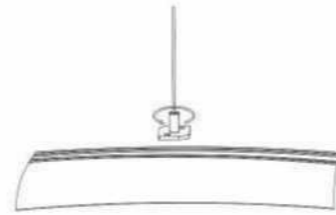

Step 04:
Move the slider to suitable position



Step 05:
Lock the slider



Step 06:
Hang the circle by the steel wire



Step 07:
Connecting the driver

ALP3050C

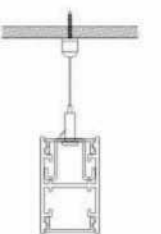
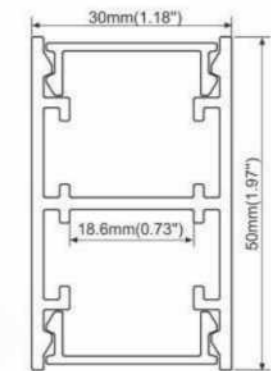
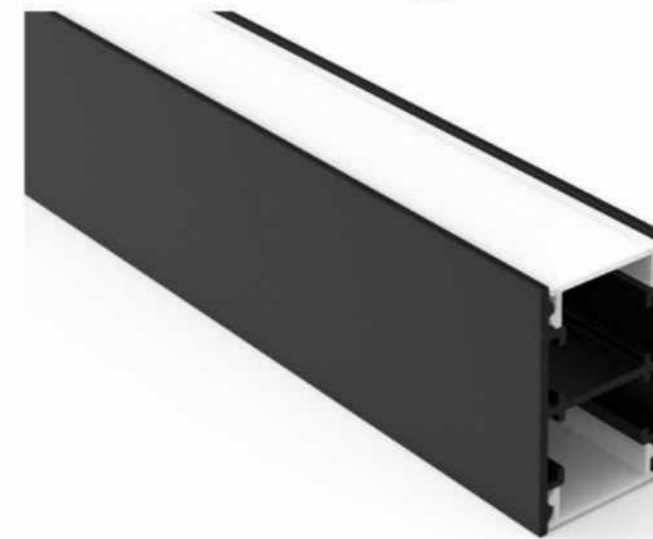
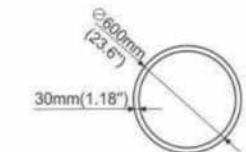
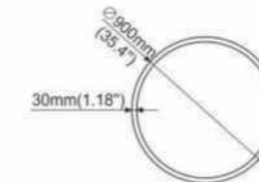
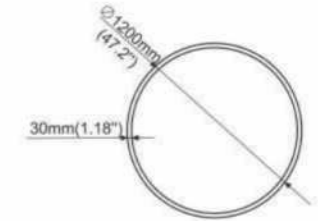
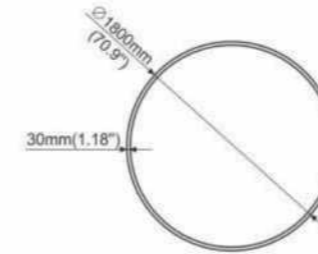

Hanging bracket



Connector



Steel wire

ALP3050C
Installation methods



Step 01:
Slide the U shape hanging clip into the profile



Step 02:
Connecting the curved profile by connector



Step 03:
Stick the led board inside the profile(down light)



Step 04:
Press the curved cover into the profile(down light)



Step 05:
Stick the led board inside the profile(up light)



Step 06:
Lock the U shape clip



Step 07:
Press the curved cover(after drilling the hole) into the profile(up light)

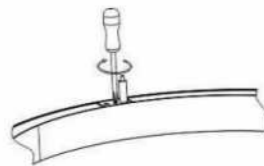

Step 08:
Fix the U shape clip on suitable position by screws



Step 09:
Hang the circle by the steel wire



Step 10:
Connecting the driver

ALP50C

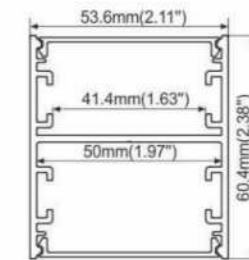
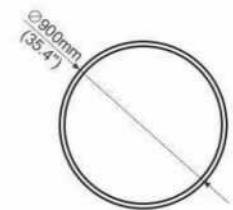
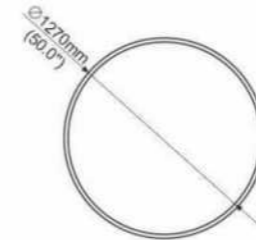
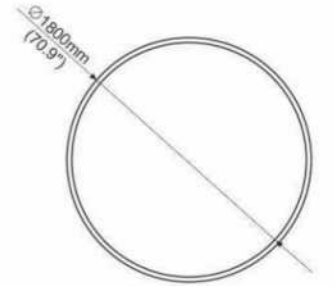
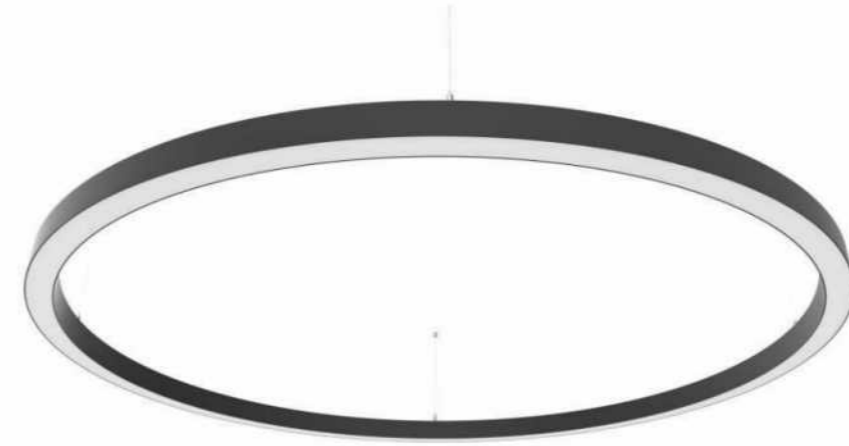

Hanging clip



Connector



Steel wire



Curved led board

ALP30C

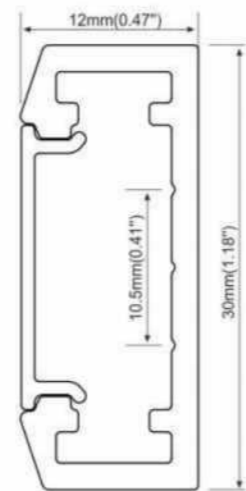
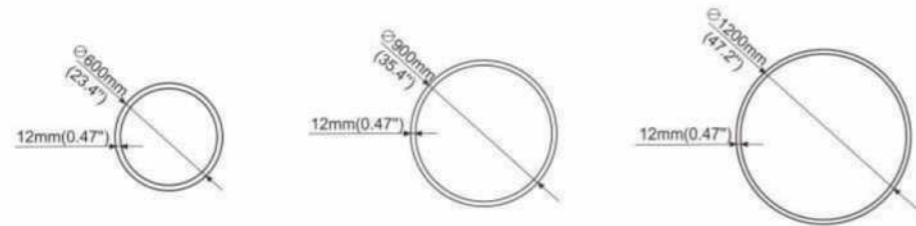

- PC Diffused cover
 - Cover bent inward
- Light Source: 2835 SMD LED strip, 120leds/m
 Installation: Suspended
 Diameter: 600mm or 900mm or 1200mm

ALP30C0

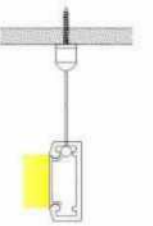
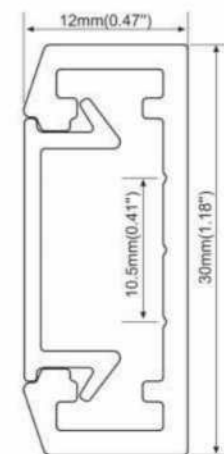
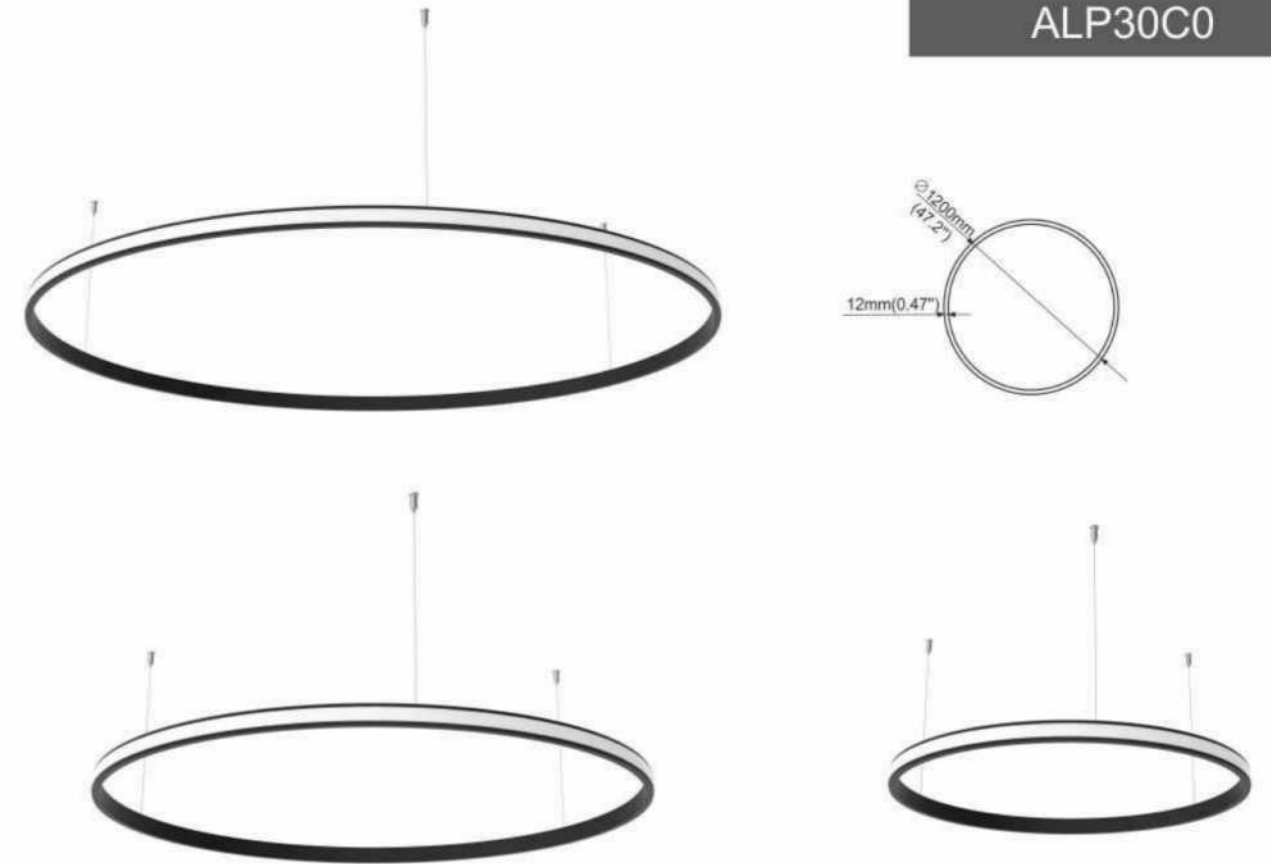

- PC Diffused cover
- Cover bent outward

ALP1202

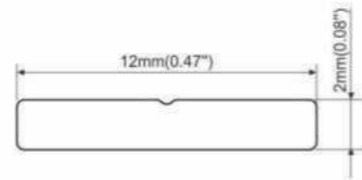

Aluminum board for heat dissipation
12x2mm
about 14W/M

ALP2002

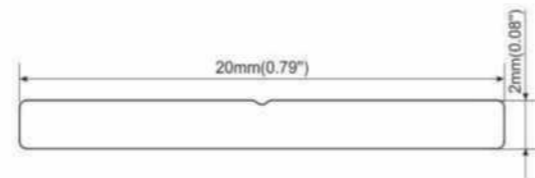
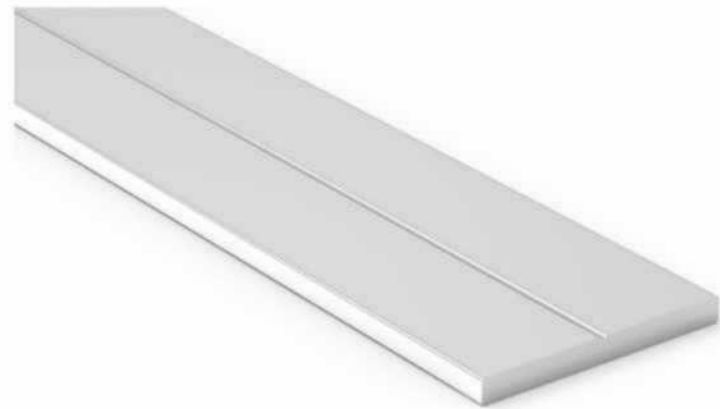

Aluminum board for heat dissipation
20x2mm
about 20W/M

ALP2502

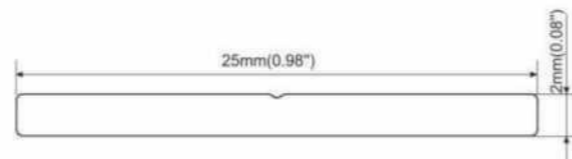

Aluminum board for heat dissipation
25x2mm
about 30W/M

HD5050

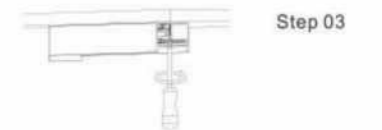
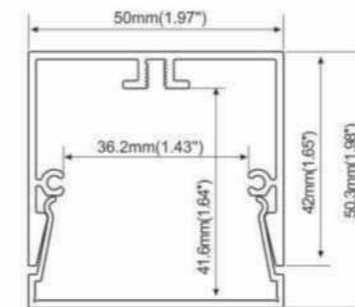
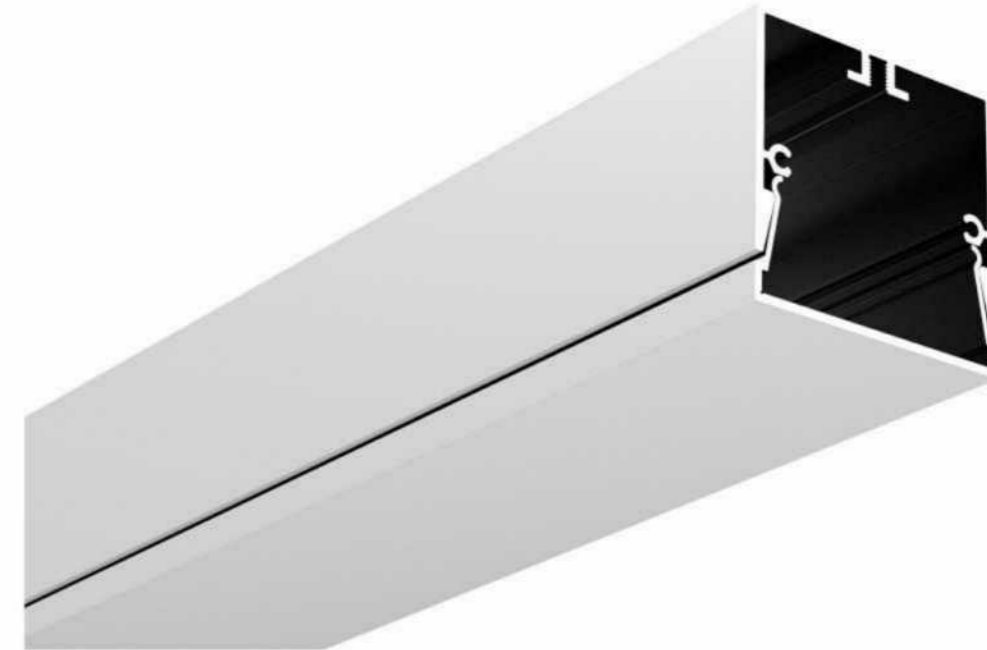

RDB01

Round driver box for circles

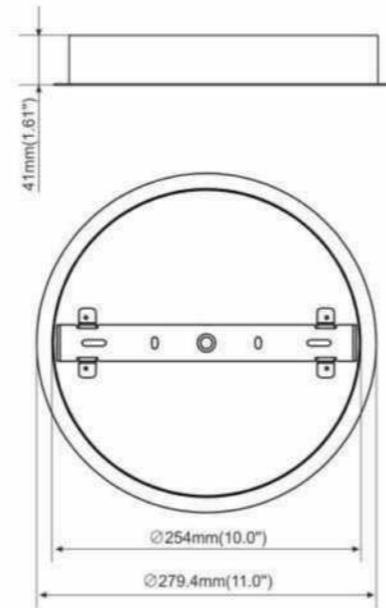

RDB02

Round driver box for circles

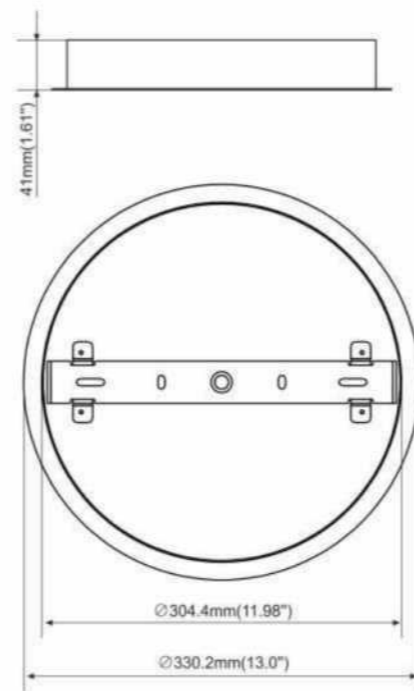

	For LS30 series LM3030LS30P6	For LS40 series LM3030LS40P9	For LS50 series LM3030LS50P14W
Size (mm)	132.5X20X6mm	190X30X6	285X31X6mm
Power(W)	6W	9W	14W
Input Voltage(V)	15V	15V	18V
Input Current(mA)	0.4A	0.6A	0.8A
Light Output	660lm	990lm	1260lm
Color Temperature	3000K/4200K/6000K	3000K/4200K/6000K	3000K/4200K/6000K
CRI	>80	>80	>80
LED Type	3030 SMD LED	3030 SMD LED	3030 SMD LED
LED Brand	Osram	Osram	Osram

	LM2835R100012P30	LM2835R99524P30	LM5630R118524P40
Size (mm)	1000X12X5	995X24X6	1185X24X6
Power(W)	30W	30W	40W
Input Voltage(V)	30V	30V	27V
Input Current(mA)	1.0A	1.0A	1.5A
Light Output	4200lm	4200lm	5600lm
Color Temperature	3000K/4200K/6000K	3000K/4200K/6000K	3000K/4200K/6000K
CRI	>80	>80	>80
LED Type	2835 SMD LED	2835 SMD LED	5630 SMD LED
LED Brand	Samsung	Samsung	Samsung

LED Module for LS4070

	LM2835R28030P7	LM2835R114030P29
Size (mm)	280X30X6	1140X30X6
Power(W)	7.2W	29W
Input Voltage(V)	42V	42V
Input Current(mA)	0.175A	0.7A
Light Output	1000lm	4060lm
Color Temperature	3000K/4200K/6000K	3000K/4200K/6000K
CRI	>80	>80
LED Type	2835 SMD LED	2835 SMD LED
LED Brand	Samsung	Samsung

LED Module: Rigid Board

	LM2835R56024P14	LM2835R56051P21	LM2835R56068P27
Size	560*24*5mm	560*51.5*5mm	560*68.5*5mm
Power	14W	21W	27W
Light Output	1980lm	2950lm	3900lm
CRI	>80	>80	>80
Color temperature	3000k/4200k/6000k	3000k/4200k/6000k	3000k/4200k/6000k

LED Module:Flexible PCB

	LM2835F500012P14	LM2835F250024P28	LM2835F250051P34
Size	5000*12* 1.2mm	2500*24*1.2mm	2500*51.5*1.2mm
Power/meter	14W	28W	34W
Light Output/meter	1190lm	2380lm	2890lm
CRI	>80	>80	>80
Color temperature	3000k/4200k/6000k	3000k/4200k/6000k	3000k/4200k/6000k
Voltage input	DC24V	DC24V	DC24V
Cutting unit	100mm	100mm	100mm

LED Driver

	CCD36W900mA	CCD48W1200mA	CCD62W1500mA
Voltage input	100-277VAC	100-277VAC	100-277VAC
Voltage output	27-40VDC	27-40VDC	27-40VDC
Current output	900mA	1200mA	1500mA
Power Max	36W	48W	62W
Efficacy	86%	86%	86%
PF	0.98	0.98	0.98
Dimming Mode	0-10V/PWM/Resistance	0-10V/PWM/Resistance	0-10V/PWM/Resistance
Size	285*30*21mm	355*30*21mm	355*30*21mm

Contant Current Driver-Philip

	36W Non-dimmable	75W Non-dimmable	36W DALI	75W DALI
Part Number	Xitanium 36W/0.3-1A,54V,230V	Xitanium 75W/0.7-2A, 54V 230V	Xitanium 36W 0.3-1A,54V TD 230V	Xitanium75W 0.7-2A,54V TD 230V
Size (mm)	360x30x21	360x30x21	360x30x21	360*30*21
Input Voltage(V)	202-254V	202-254V	202-254V	202-254V
Power Factor	≥0.9	≥0.9	≥0.9	≥0.9
Output Current(mA)	300-1000	700-2000	300-1000	700-2000
Output Voltage(V)	27-54V	27-54V	27-54V	27-54V
Output Power Range(W)	11-37	21-75	11-37	21-75
Maximum Power(W)	36	75	36	75

Contant Voltage Driver

	CVD30W	CVD60W	CVD80W	CVD200W
Input Voltage(V)	220V-240V	220-240V	220-240V	220V-240V
Output Voltage(V)	24V	24V	24V	24V
Output Current(mA)	0-1.25A	0-2.5A	0-3.3A	0-8.3A
Power Max	30W	60W	80W	200W
Efficiency	88%	88%	88%	88%
Power Factor	≥0.95	≥0.95	≥0.95	≥0.95
Size (mm)	210x30x21	280x30x21	280x30x21	360x37x30